



STATE OF MAINE
DEPARTMENT OF HUMAN SERVICES
DIVISION OF HEALTH ENGINEERING
11 STATE HOUSE STATION
AUGUSTA, MAINE

ANGUS S. KING, JR.
GOVERNOR

04333-0010
May 8, 2002

KEVIN W. CONCANNON
COMMISSIONER

Norweco
Attn.: Joe Bush
220 Republic Street
Norwalk, OH 44857-1196

Subject: Request for Wastewater Strength Adjustment, Norweco BK 2000

Dear Mr. Bush:

On April 30, 2002 this office sent you a letter explaining assignment of variance points based upon effluent quality, in response to your request that the Division allot 20 points toward a First Time System Variance, for use of the Norweco BK 2000. It is now my understanding from discussions with Stephen Robbins, SE that Norweco would like to be allowed a disposal area sizing adjustment for use of the Norweco BK 2000.

Under provisions of Section 603.1 of the Subsurface Wastewater Disposal Rules, when, as a result of an approved pretreatment technique, the waste water entering a disposal field has a combined 5-day biochemical oxygen demand (BOD₅) and total suspended solid (TSS) concentration of less than 175 milligrams per liter, the size of the disposal field may be adjusted by multiplying by the adjustment factors prescribed in Table 603.1. When the combined BOD₅ and TSS are greater than 320 milligrams per liter, the size of the disposal field shall be adjusted, again using Table 603.1.

As you observed in your letter of July 10, 2002, the adjustment factor in Table 603.1 of the Subsurface Wastewater Disposal Rules, for a combined BOD₅ and TSS between 175 mg/l and 82 mg/l, is 0.8.

If you have any further questions, please feel free to contact me at 287-5695.

Sincerely

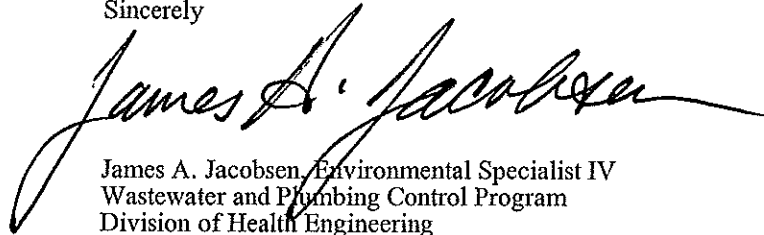

James A. Jacobsen, Environmental Specialist IV
Wastewater and Plumbing Control Program
Division of Health Engineering
e-mail: james.jacobsen@state.me.us

/jj

xc: File



PRINTED ON RECYCLED PAPER

NORWECO[®]

NORWALK WASTEWATER EQUIPMENT COMPANY
220 Republic Street
Norwalk, OH 44857-1196 U.S.A.
(419) 663-4471 Fax (419) 663-5440

July 10, 2002

Mr. James A. Jacobsen
Environmental Specialist IV
Department of Human Services
Bureau of Health
Division of Health Engineering
Wastewater & Plumbing Program
10 Statehouse Station
Augusta, ME 04333-0010

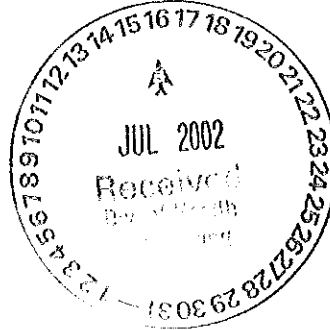

Subject: The Bio-Kinetic[®] wastewater management system, Model BK 2000

Dear Mr. Jacobsen:

I would like to thank you for your letter dated May 8, 2002. I have enclosed a copy of the letter in which you describe the formula for determining the amount of the adjustment in the size of the disposal field allowable under the provisions of section 603.0 of the Maine Subsurface Wastewater Disposal Rules. Unfortunately your letter doesn't make it clear to potential users of the Bio-Kinetic wastewater management system how the product can be applied. My original request asked for an approval from your department to grant the Bio-Kinetic wastewater management system an adjustment factor of .08.

I requested this adjustment factor of .08 based on the documentation we provided, including NSF performance evaluations of Singlair[®] wastewater treatment plants with and without the Bio-Kinetic system. In a letter to Norweco dated April 9, 2001, you granted our request for 10 points towards first time variances pursuant to Table 1900.11 of the Maine State Plumbing Code. I have enclosed a copy of that letter in which you stated, "10 points is a reasonable allowance."

In order to clarify installation parameters to Bio-Kinetic wastewater management system users in Maine, we are requesting written confirmation from your office that an adjustment factor of .08 is allowable when designing a subsurface wastewater treatment system that includes a BK 2000 upstream of the disposal field. Our interpretation of section 603.0 and Table 603.01 of the Maine Subsurface Wastewater Disposal Rules suggests a .08 adjustment factor is acceptable. Would you please confirm that our interpretation is correct?

We greatly appreciate your assistance in this matter. Upon receipt of your confirmation we will be able to provide wastewater professionals in the state of

Maine with the information they need to help their customers make the best decisions possible concerning their wastewater systems.

Sincerely,

NORWECO, INC.

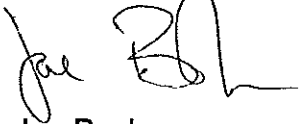

Joe Bush
Product Distribution Manager

JB/smc
Enclosures

PHONE (419) 668-4471 • FAX (419) 663-5440

NORWECO.
NORWALK WASTEWATER EQUIPMENT COMPANY

JOE BUSH
Project Distribution Manager
email@norweco.com

waste-
water
treatment
systems

220 REPUBLIC STREET • NORWALK, OH 44857 USA
www.norweco.com

Recycled ♻️

NORWECO.
NORWALK WASTEWATER EQUIPMENT COMPANY

220 REPUBLIC STREET, NORWALK, OHIO 44857-1196



STATE OF MAINE
 DEPARTMENT OF HUMAN SERVICES
 DIVISION OF HEALTH ENGINEERING
 11 STATE HOUSE STATION
 AUGUSTA, MAINE
 04333-0010

ANGUS S. KING, JR.
 GOVERNOR

KEVIN W. CONCANNON
 COMMISSIONER

May 8, 2002

Norweco
 Attn.: Joe Bush
 220 Republic Street
 Norwalk, OH 44857-1196

Subject: Request for Wastewater Strength Adjustment, Norweco BK 2000

Dear Mr. Bush:

On April 30, 2002 this office sent you a letter explaining assignment of variance points based upon effluent quality, in response to your request that the Division allot 20 points toward a First Time System Variance, for use of the Norweco BK 2000. It is now my understanding from discussions with Stephen Robbins, SE that Norweco would like to be allowed a disposal area sizing adjustment for use of the Norweco BK 2000.

Under provisions of Section 603.1 of the Subsurface Wastewater Disposal Rules, when, as a result of an approved pretreatment technique, the waste water entering a disposal field has a combined 5-day biochemical oxygen demand (BOD₅) and total suspended solid (TSS) concentration of less than 175 milligrams per liter, the size of the disposal field may be adjusted by multiplying by the adjustment factors prescribed in Table 603.1. When the combined BOD₅ and TSS are greater than 320 milligrams per liter, the size of the disposal field shall be adjusted, again using Table 603.1.

TABLE 603.1
 ADJUSTMENT FACTOR FOR WASTE WATER STRENGTHS
 DIFFERENT FROM TYPICAL DOMESTIC WASTE WATER

| Strength of waste water entering the disposal field (BOD ₅ plus TSS) | Adjustment factor (AF) |
|---------------------------------------------------------------------------------|------------------------|
| 30 or less mg/l | 0.5 |
| 52 | 0.6 |
| 82 | 0.7 |
| 122 | 0.8 |
| 175 | 0.9 |
| 240 | 1.0 |
| 320 | 1.1 |
| 420 | 1.2 |
| 530 | 1.3 |
| 660 | 1.4 |
| 810 | 1.5 |



PRINTED ON RECYCLED PAPER

If you have any further questions, please feel free to contact me at 287-5695.

Sincerely

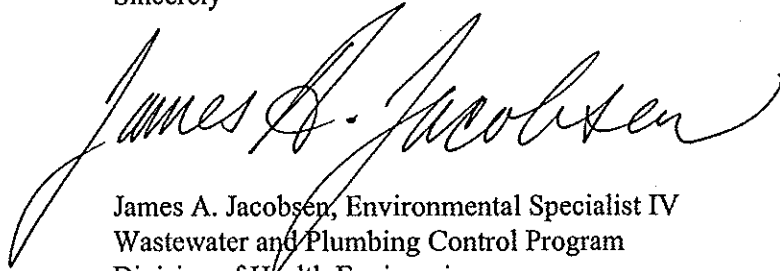
A handwritten signature in cursive script that reads "James A. Jacobsen". The signature is written in black ink and is positioned above the typed name and contact information.

James A. Jacobsen, Environmental Specialist IV
Wastewater and Plumbing Control Program
Division of Health Engineering
e-mail: james.jacobsen@state.me.us

/jaj

xc: File
Stephen Robbins, SE



STATE OF MAINE
DEPARTMENT OF HUMAN SERVICES
DIVISION OF HEALTH ENGINEERING
10 STATE HOUSE STATION
AUGUSTA, MAINE

ANGUS S. KING, JR.
GOVERNOR

04333-0010

April 9, 2001

KEVIN W. CONCANNON
COMMISSIONER

Norweco
Attn.: Donald S. Bach, Vice President
220 Republic Street
Norwalk, OH 44857-1196

Subject: Product Registration, Norweco Bio-Kinetic Wastewater Management System BK 2000

Dear Mr. Bach:

Thank you for your letter dated March 22, 2001 regarding your company's product. The Norweco Bio-Kinetic Wastewater Management System BK 2000 (BK 2000) is a self-contained plate filter installed between a treatment tank and the point of final effluent disposal. According to the information you provided, the BK 2000 is able to attenuate peak flows, and significantly reduce BOD₅ and TSS levels (ref.: Wilks property data sheet). You have requested that the BK 2000 be allowed 10 points toward first time variances, pursuant to Table 1900.11 of the Maine State Plumbing Code, Subsurface Wastewater Disposal Rules.

Under provisions of Section 1802 of the Maine State Plumbing Code, Subsurface Wastewater Disposal Rules any manufacturer or distributor submitting a new product for code registration needs to demonstrate that:

1. The product is designed to protect public health, prevent the creation of any nuisance, and prevent environmental pollution to the same extent as comparable products presently authorized by Department for use in this code, and
2. The product is based on sound engineering principles and can be expected to provide the same level of protection to public health and the environment as offered by the authorized products presently authorized by the Department for use in this code.

According to the information you provided, the BK 2000 has received NSF Standard 46 approval. On that basis, the Division has determined that the BK 2000 is acceptable for use in the State of Maine, provided that it is installed, operated, and maintained in conformance with the manufacturer's directions. Regarding points from Table 1900.11, the points are allowed on a performance basis, not on a per-brand or model basis, and no special permission is required to do so-only supporting data. Therefore, you may wish to collect more data than that in the Wilks' data sheet to support your product. In the meantime, 10 points is a reasonable allowance.

Because installation and owner maintenance has a significant effect on the working order of onsite sewage disposal systems, including their components, the Division makes no representation or guarantee as to the efficiency and/or operation of Norweco Bio-Kinetic Wastewater Management System BK 2000. Further, registration of this product for use in the State of Maine does not represent Division endorsement, preference, or recommendation for this product over similar products.

If you have any questions please feel free to contact me at (207) 287-5695.

Sincerely,

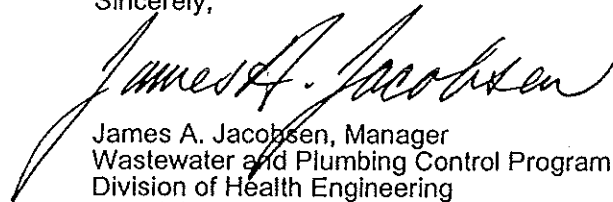

James A. Jacobsen, Manager
Wastewater and Plumbing Control Program
Division of Health Engineering
e-mail: james.jacobsen@state.me.us

xc: Product File



PRINTED ON RECYCLED PAPER

NORWECO[®]

NORWALK WASTEWATER
EQUIPMENT COMPANY
220 Republic Street
Norwalk, OH 44857-1196 U.S.A.
Phone (419) 668-4471 Fax (419) 663-5440
www.norweco.com

RECEIVED

FEB 01 2005

WASTEWATER &
PLUMBING PROGRAM

January 28, 2005

Mr. Russell Martin
11 State House Sta
Augusta, ME 04333-0011

Dear Mr. Martin:

In accordance with the Maine Subsurface Disposal Rules Table 603.1, using the BK 2000 will allow up to a 30% reduction in the size of the leach field. The BK 2000, in accordance with Table 1900.11, qualifies for a minimum of 10 points toward a First Time System Variance.

You can now design systems with the peace of mind that you are using a proven technology, not a fad that has recently appeared on the market. The Bio-Kinetic[®] has dramatically improved effluent quality in thousands of systems for over a decade.

The BK 2000 is purchased and serviced locally through a reliable network of experienced companies.

For additional information, including CAD drawings, give us a call at (419) 668-4471, fax at (419) 663-5440 or fill out the customer information request form by visiting our website at www.norweco.com/BK2000.

Sincerely,

NORWECO, INC.



Shelly L. Wybensinger
Inside Sales Manager

SLW/rlc

Enclosures: Maine Approval
BK 2000 Specifications
Drawing PC-5-9623
Response Card



STATE OF MAINE
 DEPARTMENT OF HUMAN SERVICES
 DIVISION OF HEALTH ENGINEERING
 STATE HOUSE STATION
 AUGUSTA, MAINE
 04333-0010

ANGUS S. KING, JR.
 GOVERNOR

KEVIN W. CONCANNON
 COMMISSIONER

May 8, 2002

Norweco
 Attn.: Joe Bush
 220 Republic Street
 Norwalk, OH 44857-1196

Subject: Request for Variance Points Allotment, Norweco BK 2000

Dear Mr. Bush:

Thank you for your letter of March 19, 2002 which we received on April 30, 2002. IN your letter you ask the Division to allot 20 points toward a First Time System Variance, for use of the Norweco BK 2000.

The Division no longer grants points to specific devices. The Maine State Plumbing Code, Subsurface Wastewater Disposal Rules now contains a table in the First Time System Variance section, which grants variance points based upon effluent quality:

TABLE 1900.11
 USE OF ADVANCED TREATMENT DEVICES OR SYSTEMS

| Strength of effluent (BOD ₅ plus TSS) | Points |
|-----------------------------------------------------|--------|
| 150 to 101 mg/l | 5 |
| 100 to 51 mg/l | 10 |
| 50 to 11 mg/l | 15 |
| 10 mg/l or less | 20 |

Therefore, any device which treats wastewater to a level of 10 mg/l or less of combined BOD₅ and TSS may take 20 points toward a First Time System Variance.

If you have any further questions, please feel free to contact me at 287-5695.

Sincerely

James A. Jacobsen, Environmental Specialist IV
 Wastewater and Plumbing Control Program
 Division of Health Engineering
 e-mail: james.jacobsen@state.me.us

/jaj

xc: File



100% RECYCLED PAPER



STATE OF MAINE
 DEPARTMENT OF HUMAN SERVICES
 DIVISION OF HEALTH ENGINEERING
 11 STATE HOUSE STATION
 AUGUSTA, MAINE
 04333-0010

ANGUS S. KING, JR.
 GOVERNOR

KEVIN W. CONCANNON
 COMMISSIONER

May 8, 2002

Norweco
 Attn.: Joe Bush
 220 Republic Street
 Norwalk, OH 44857-1196

Subject: Request for Wastewater Strength Adjustment, Norweco BK 2000

Dear Mr. Bush:

On April 30, 2002 this office sent you a letter explaining assignment of variance points based upon effluent quality, in response to your request that the Division allot 20 points toward a First Time System Variance, for use of the Norweco BK 2000. It is now my understanding from discussions with Stephen Robbins, SE that Norweco would like to be allowed a disposal area sizing adjustment for use of the Norweco BK 2000.

Under provisions of Section 603.1 of the Subsurface Wastewater Disposal Rules, when, as a result of an approved pretreatment technique, the waste water entering a disposal field has a combined 5-day biochemical oxygen demand (BOD₅) and total suspended solid (TSS) concentration of less than 175 milligrams per liter, the size of the disposal field may be adjusted by multiplying by the adjustment factors prescribed in Table 603.1. When the combined BOD₅ and TSS are greater than 320 milligrams per liter, the size of the disposal field shall be adjusted, again using Table 603.1.

TABLE 603.1
 ADJUSTMENT FACTOR FOR WASTE WATER STRENGTHS
 DIFFERENT FROM TYPICAL DOMESTIC WASTE WATER

| Strength of waste water entering the disposal field (BOD ₅ plus TSS) | Adjustment factor (AF) |
|---------------------------------------------------------------------------------|------------------------|
| 30 or less mg/l | 0.5 |
| 52 | 0.6 |
| 82 | 0.7 |
| 122 | 0.8 |
| 175 | 0.9 |
| 240 | 1.0 |
| 320 | 1.1 |
| 420 | 1.2 |
| 530 | 1.3 |
| 660 | 1.4 |
| 810 | 1.5 |



PRINTED ON RECYCLED PAPER

If you have any further questions, please feel free to contact me at 287-5695.

Sincerely

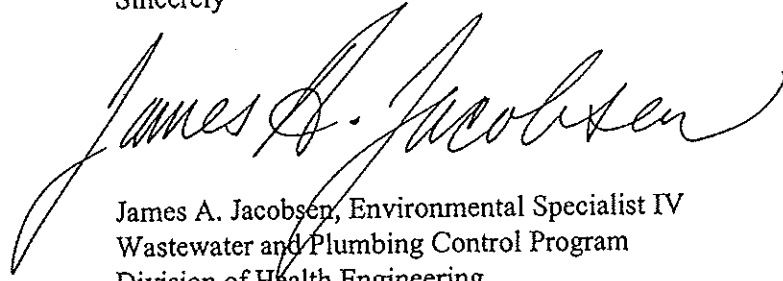
A handwritten signature in cursive script that reads "James A. Jacobsen". The signature is written in black ink and is positioned above the typed name and contact information.

James A. Jacobsen, Environmental Specialist IV
Wastewater and Plumbing Control Program
Division of Health Engineering
e-mail: james.jacobsen@state.me.us

/jaj

xc: File
Stephen Robbins, SE



STATE OF MAINE
DEPARTMENT OF HUMAN SERVICES
DIVISION OF HEALTH ENGINEERING
11 STATE HOUSE STATION
AUGUSTA, MAINE

ANGUS S. KING, JR.
GOVERNOR

04333-0010
May 8, 2002

KEVIN W. CONCANNON
COMMISSIONER

Norweco
Attn.: Joe Bush
220 Republic Street
Norwalk, OH 44857-1196

Subject: Request for Wastewater Strength Adjustment, Norweco BK 2000

Dear Mr. Bush:

On April 30, 2002 this office sent you a letter explaining assignment of variance points based upon effluent quality, in response to your request that the Division allot 20 points toward a First Time System Variance, for use of the Norweco BK 2000. It is now my understanding from discussions with Stephen Robbins, SE that Norweco would like to be allowed a disposal area sizing adjustment for use of the Norweco BK 2000.

Under provisions of Section 603.1 of the Subsurface Wastewater Disposal Rules, when, as a result of an approved pretreatment technique, the waste water entering a disposal field has a combined 5-day biochemical oxygen demand (BOD₅) and total suspended solid (TSS) concentration of less than 175 milligrams per liter, the size of the disposal field may be adjusted by multiplying by the adjustment factors prescribed in Table 603.1. When the combined BOD₅ and TSS are greater than 320 milligrams per liter, the size of the disposal field shall be adjusted, again using Table 603.1.

As you observed in your letter of July 10, 2002, the adjustment factor in Table 603.1 of the Subsurface Wastewater Disposal Rules, for a combined BOD₅ and TSS between 175 mg/l and 320 mg/l, is 0.8.

If you have any further questions, please feel free to contact me at 287-5695.

Sincerely

James A. Jacobsen, Environmental Specialist IV
Wastewater and Plumbing Control Program
Division of Health Engineering
e-mail: james.jacobsen@state.me.us

/jaj

xc: File



BIO-KINETIC[®]

WASTEWATER MANAGEMENT SYSTEM

MODEL BK 2000

GENERAL SPECIFICATIONS

The contractor shall furnish and install one complete Bio-Kinetic wastewater management system with Bio-Kinetic tertiary device, including all applicable equipment, as described in the following specifications. All domestic wastewater shall pass through the Bio-Kinetic wastewater management system for advanced treatment prior to being returned to the environment. Settling and storage of suspended solids, flow equalization, filtration and chemical addition shall be accomplished for the wastewater treatment facility by the Bio-Kinetic wastewater management system. The advanced treatment system shall be a Bio-Kinetic Model BK 2000 wastewater management system, as manufactured by Norweco, Inc., Norwalk, Ohio, USA. The wastewater management system shall be serviceable from grade and shall include a solids settling and retention basin, Bio-Kinetic tertiary device, anti-shear inlet and outlet couplings, safety/service guard, lockable access cover, compression clamp, system mounting casting and extension risers as required.

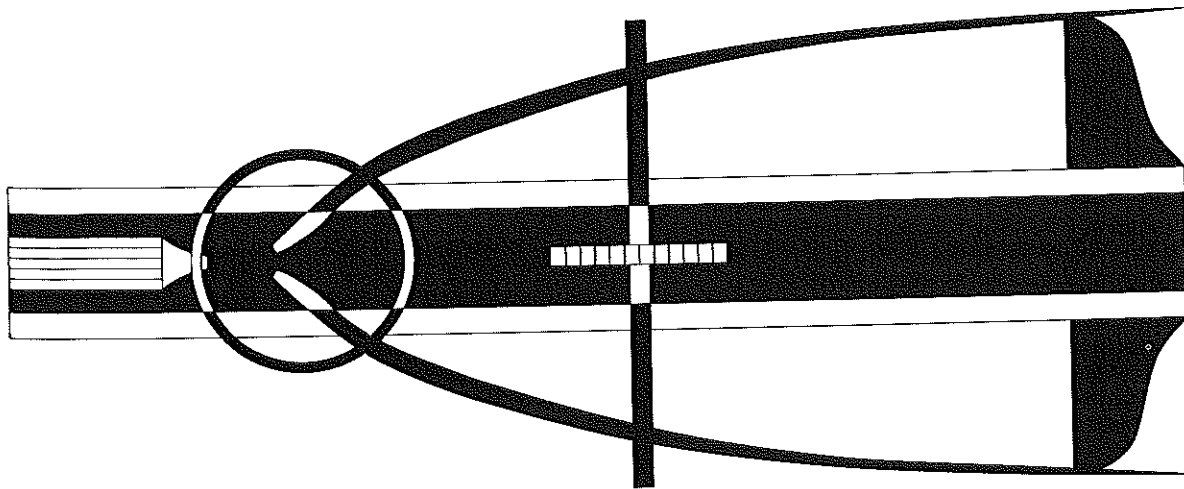

OPERATING CONDITIONS

The Bio-Kinetic wastewater management system shall be an integral part of the overall wastewater treatment and disposal facility. The system shall be rated to accommodate domestic wastewater flows up to 2,000 gallons per day when used downstream of a properly sized treatment facility. Total holding capacity of the wastewater treatment facility shall provide a minimum of 24 hour retention of the average design daily flow. Design of the wastewater treatment facility, including primary/secondary treatment and wastewater management system, shall insure reliable, long term performance without upset even when the significant runoff period is six hours. Hydraulic design considerations of the treatment facility and wastewater management system shall be such that intermittent peak flow factors as high as four shall not upset hydraulic reliability within the facility. Use of the Bio-Kinetic wastewater management system, when installed by an authorized agent, shall be approved by the local governing regulatory agency.

GENERAL NOTES:

- ① FALL THROUGH THE BIO-KINETIC® WASTEWATER MANAGEMENT SYSTEM IS ONE INCH FROM INLET INVERT TO OUTLET INVERT.
- ② FINISHED GRADE MUST BE MAINTAINED AT LEAST 3 INCHES BELOW THE MOISTURE DRIP LIP OF THE ACCESS COVER.
- ③ SAND OR FINE GRAVEL MUST BE USED TO BACKFILL THE BIO-KINETIC® WASTEWATER MANAGEMENT SYSTEM.
- ④ ON DEEPER INSTALLATIONS, RISERS MUST BE USED TO EXTEND THE MOUNTING CASTING TO GRADE.
- ⑤ WHEN ADDITIONAL HOLDING CAPACITY IS REQUIRED, RING SECTIONS CAN BE ADDED TO INCREASE THE DEPTH OF THE SETTLING AND RETENTION BASIN.
- ⑥ DIMENSIONS SHOWN ARE BASED ON A STANDARD BK 2000 BASIN. SEGMENTED BASINS AND BASINS CONTAINING RISERS OR RISERS WILL REQUIRE ADJUSTMENT.

PROJECT ENGINEER'S APPROVAL:
I (WE) HEREBY CERTIFY THAT THIS DRAWING HAS BEEN CHECKED AND IS APPROVED FOR USE IN CONFORMITY WITH THE CONTRACT DOCUMENTS.

DATE: _____ NAME: _____

CONTRACTOR'S CERTIFICATION:
I (WE) HEREBY CERTIFY THAT THIS DRAWING HAS BEEN CHECKED AND IS APPROVED FOR USE IN CONFORMITY WITH THE CONTRACT DOCUMENTS.

DATE: _____ NAME: _____

| CRITICAL DIMENSIONS | |
|---------------------|-----------|
| (A) | 3'-4 1/2" |
| (B) | 3'-9 1/2" |
| (C) | 5'-7 1/4" |
| (D) | 0'-8 1/2" |
| (E) | 2'-2 1/2" |
| (F) | 2'-0" |
| (G) | 2'-0" |
| (H) | 6'-4 1/2" |
| (I) | |
| (J) | |
| (K) | |
| (L) | |
| (M) | |
| (N) | |
| (O) | |
| (P) | |
| (Q) | |
| (R) | |

TOLERANCES

NOMINAL DIMENSIONS ARE SHOWN AND MAY VARY ±3/16" IN LENGTH FOR EACH COMPONENT.

U.S. PATENT & TRADEMARK OFFICE
REG. NO. 4,111,111
CLASS. 281-100

NDUREA®
BK 2000
BIO-KINETIC®
WASTEWATER
MANAGEMENT
SYSTEM

U.S. FOREIGN PATENTS PENDING

MAI

PC-5-0023

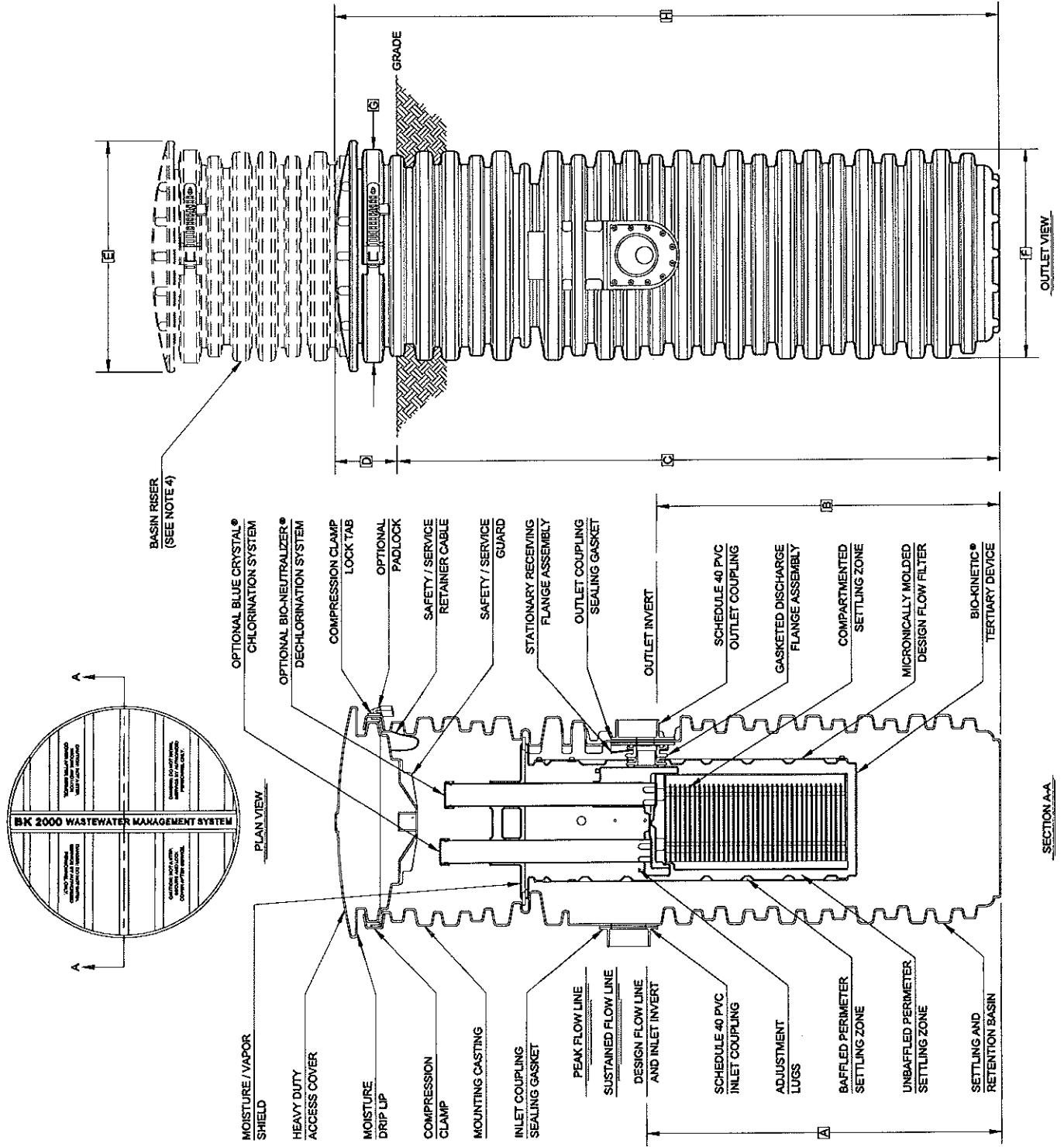

BIO-KINETIC®

WASTEWATER MANAGEMENT SYSTEM

TEST RESULTS AND REMOVAL EFFICIENCIES

Improved treatment efficiencies and system life are guaranteed whenever management of wastewater flow is provided. The Model BK 2000 protects domestic wastewater treatment plants from hydraulic surges, biosolids washout and organic overload with chlorination and dechlorination also available. Flow equalization maintains critical design detention time in wastewater treatment processes, resulting in a final effluent that is dramatically improved.

Higher effluent quality increases the operating life of sand filters, mounds, wetlands, leaching beds and other soil absorption, irrigation and treatment systems. Septic tanks followed by a Bio-Kinetic wastewater management system provide an effluent that is 99.99% free of CBOD and TSS. Aerobic wastewater treatment systems utilizing a Model BK 2000 Bio-Kinetic wastewater management system provide an effluent that is 99.999% free of CBOD and TSS.

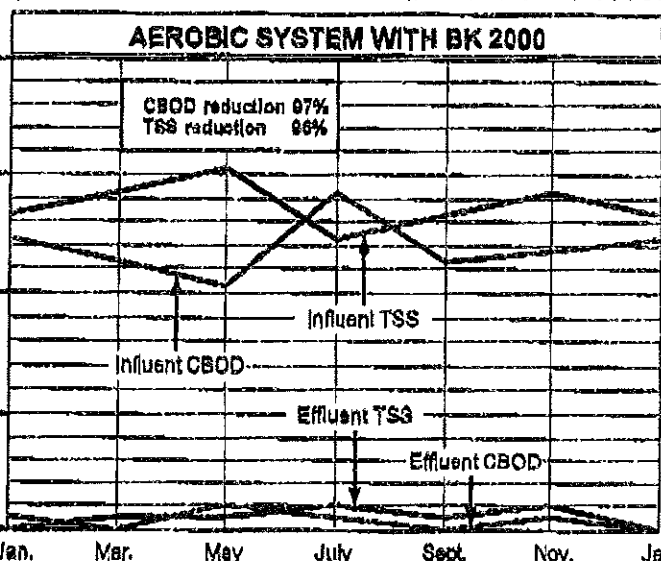
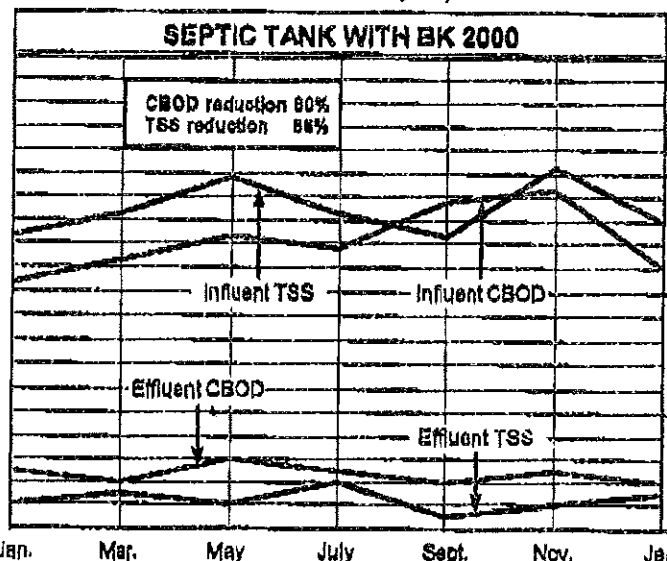

| TYPICAL TREATMENT RESULTS | | | | *BK2K with CL |
|--------------------------------------------------|---------------------------------------------------------------------------|-------------|-------------|---------------------------------------------------------|
| LOADING | APPLURTENANCES | FINAL CBOD | FINAL TSS | TYPE OF SYSTEM |
| 2 Adults, 2 Children, 3 Bedrooms, 2 Baths | Well water, clothes washer, dishwasher and disposal | 18 - 74 ppm | 10 - 46 ppm | Septic tank discharging to evapotranspiration mound |
| 2 Adults, 5 Children, 5 Bedrooms, 3 1/2 Baths | Well water, clothes washer, dishwasher, water softener and disposal | <5 - 28 ppm | <5 - 32 ppm | Aerobic system discharging to intermittent stream |
| 1 Adult, 2 Children, 3 Bedrooms, 1 1/2 Baths | City water, clothes washer and dishwasher | <5 - 15 ppm | <5 - 18 ppm | Aerobic system discharging to sub-surface tile field |
| 2 Adults, 2 Bedrooms, 2 Baths | Rural water, clothes washer, dishwasher and disposal | 21 - 50 ppm | 8 - 22 ppm | Septic tank discharging to sub-surface sand filter |
| 2 Adults, 3 Children, 4 Bedrooms, 3 Baths | Well water, clothes washer, water softener and disposal | 25 - 80 ppm | 22 - 38 ppm | Septic tank discharging to drip irrigation system |
| 2 Adults, 4 Children, 4 Bedrooms, 2 1/2 Baths | Chlorinated cistern water, clothes washer, dishwasher and disposal | <5 - 22 ppm | <5 - 26 ppm | Aerobic system discharging to storm sewer |

Superior treatment efficiencies and extended disposal system life are guaranteed when solids settling, flow equalization, filtration and disinfection are added to any septic tank or aerobic treatment device. The Model BK 2000 Bio-Kinetic wastewater management system provides each of these vital elements for any conventional domestic wastewater treatment system.

PROGRESS THROUGH



SERVICE SINCE 1906



STATE OF MAINE
 DEPARTMENT OF HUMAN SERVICES
 DIVISION OF HEALTH ENGINEERING
 11 STATE HOUSE STATION
 AUGUSTA, MAINE
 04333-0010

ANGUS S. KING, JR.
 GOVERNOR

KEVIN W. CONCANNON
 COMMISSIONER

May 8, 2002

Norweco
 Attn.: Joe Bush
 220 Republic Street
 Norwalk, OH 44857-1196

Subject: Request for Wastewater Strength Adjustment, Norweco BK 2000

Dear Mr. Bush:

On April 30, 2002 this office sent you a letter explaining assignment of variance points based upon effluent quality, in response to your request that the Division allot 20 points toward a First Time System Variance, for use of the Norweco BK 2000. It is now my understanding from discussions with Stephen Robbins, SE that Norweco would like to be allowed a disposal area sizing adjustment for use of the Norweco BK 2000.

Under provisions of Section 603.1 of the Subsurface Wastewater Disposal Rules, when, as a result of an approved pretreatment technique, the waste water entering a disposal field has a combined 5-day biochemical oxygen demand (BOD₅) and total suspended solid (TSS) concentration of less than 175 milligrams per liter, the size of the disposal field may be adjusted by multiplying by the adjustment factors prescribed in Table 603.1. When the combined BOD₅ and TSS are greater than 320 milligrams per liter, the size of the disposal field shall be adjusted, again using Table 603.1.

**TABLE 603.1
 ADJUSTMENT FACTOR FOR WASTE WATER STRENGTHS
 DIFFERENT FROM TYPICAL DOMESTIC WASTE WATER**

| Strength of waste water entering the disposal field (BOD ₅ plus TSS) | Adjustment factor (AF) |
|---------------------------------------------------------------------------------|------------------------|
| 30 or less mg/l | 0.5 |
| 52 | 0.6 |
| 82 | 0.7 |
| 122 | 0.8 |
| 175 | 0.9 |
| 240 | 1.0 |
| 320 | 1.1 |
| 420 | 1.2 |
| 530 | 1.3 |
| 660 | 1.4 |
| 810 | 1.5 |



PRINTED ON RECYCLED PAPER

If you have any further questions, please feel free to contact me at 287-5695.

Sincerely

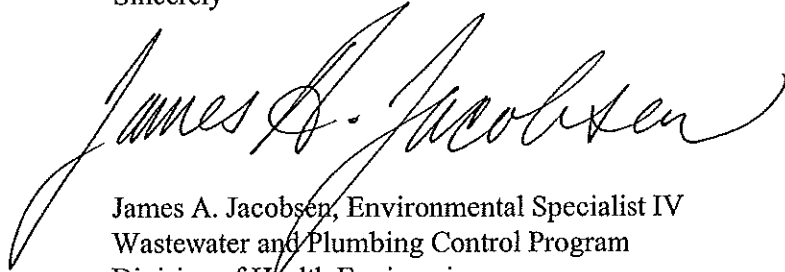
A handwritten signature in cursive script that reads "James A. Jacobsen". The signature is written in black ink and is positioned above the typed name and contact information.

James A. Jacobsen, Environmental Specialist IV
Wastewater and Plumbing Control Program
Division of Health Engineering
e-mail: james.jacobsen@state.me.us

/jaj

xc: File
Stephen Robbins, SE



STATE OF MAINE
 DEPARTMENT OF HUMAN SERVICES
 DIVISION OF HEALTH ENGINEERING
 STATE HOUSE STATION
 AUGUSTA, MAINE
 04333-0010

ANGUS S. KING, JR.
 GOVERNOR

KEVIN W. CONCANNON
 COMMISSIONER

May 8, 2002

Norweco
 Attn.: Joe Bush
 220 Republic Street
 Norwalk, OH 44857-1196

Subject: Request for Variance Points Allotment, Norweco BK 2000

Dear Mr. Bush:

Thank you for your letter of March 19, 2002 which we received on April 30, 2002. IN your letter you ask the Division to allot 20 points toward a First Time System Variance, for use of the Norweco BK 2000.

The Division no longer grants points to specific devices. The Maine State Plumbing Code, Subsurface Wastewater Disposal Rules now contains a table in the First Time System Variance section, which grants variance points based upon effluent quality:

TABLE 1900.11
 USE OF ADVANCED TREATMENT DEVICES OR SYSTEMS

| Strength of effluent (BOD ₅ plus TSS) | Points |
|-----------------------------------------------------|--------|
| 150 to 101 mg/l | 5 |
| 100 to 51 mg/l | 10 |
| 50 to 11 mg/l | 15 |
| 10 mg/l or less | 20 |

Therefore, any device which treats wastewater to a level of 10 mg/l or less of combined BOD₅ and TSS may take 20 points toward a First Time System Variance.

If you have any further questions, please feel free to contact me at 287-5695.

Sincerely

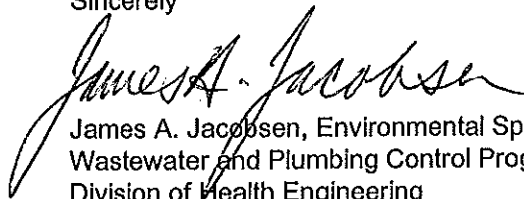

James A. Jacobsen, Environmental Specialist IV
 Wastewater and Plumbing Control Program
 Division of Health Engineering
 e-mail: james.jacobsen@state.me.us

/jaj

xc: File



PRINTED ON RECYCLED PAPER

NORWECO

NORWALK WASTEWATER
EQUIPMENT COMPANY
220 Republic Street
Norwalk, OH 44857-1196 U.S.A.
Phone (419) 668-4471 Fax (419) 663-5440
www.norweco.com

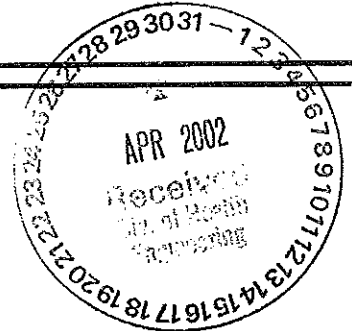

March 19, 2002

Mr. James A. Jacobson
Wastewater & Plumbing Control Program
Division of Health Engineering
10 State House Station
Augusta, ME 04333-0010

Dear Mr. Jacobson:

Thank you for your letter of April 9, 2001, granting the BK 2000 a 10 point value towards new system variances in the state of Maine. It is my understanding that the BK 2000 has now been used in Maine to achieve variances and to provide longevity for other new and existing systems. Meanwhile, Norweco requests that when used, the BK 2000 be granted a 20% reduction in disposal area sizing. This size reduction appears balanced with other product approvals and Section 603.0 of your Waste Water Disposal Rules.

In support of this request, we previously provided your department with documentation of successful completion of NSF Standard 46 test protocol, copies of Norweco's Singulair® 960 system without the BK device, and the NSF Standard 40 test results for the Singulair 960 system with the BK device. This submission should fulfill the requirements of the Maine Rules, section 1802.3, demonstrating that the device is based on sound engineering principals.

Concerning long term certified data for the Bio-Kinetic® wastewater management system; as you are aware, no certifying organization has established test protocols under which the Bio-Kinetic wastewater management system can be tested. Therefore, please refer to the data provided previously from a county program.

We thank you in advance for your favorable review of our request. While the Bio-Kinetic filter has been used as the integral part of the Singulair system for more than a decade, with several hundred thousand units installed worldwide, the BK 2000 itself is a one of a kind advanced treatment system, relatively new to the conventional wastewater disposal market.

If we can provide any further information or assistance, please contact me at your convenience.

Sincerely,

NORWECO, INC

Joe Bush
Product Distribution Manager

NORWECO[®]

NORWALK WASTEWATER
EQUIPMENT COMPANY
220 Republic Street
Norwalk, OH 44857-1196 U.S.A.
Phone (419) 668-4471 Fax (419) 663-5440
www.norweco.com

March 19, 2002

Mr. James A. Jacobson
Wastewater & Plumbing Control Program
Division of Health Engineering
10 State House Station
Augusta, ME 04333-0010

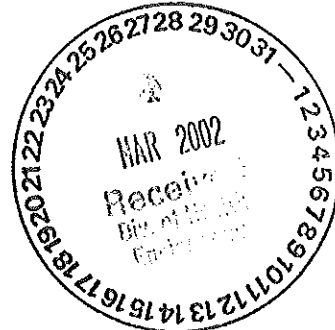

Dear Mr. Jacobson:

Thank you for your letter of April 9, 2001, granting the BK 2000 a 10 point value towards new system variances in the state of Maine. It is my understanding that the BK 2000 has now been used in Maine to achieve variances and to provide longevity for other new and existing systems. Meanwhile, Norweco requests that when used, the BK 2000 be granted a 20% reduction in disposal area sizing. This size reduction appears balanced with other product approvals and Section 603.0 of your Waste Water Disposal Rules.

In support of this request, we previously provided your department with documentation of successful completion of NSF Standard 46 test protocol, copies of Norweco's Singulair[®] 960 system without the BK device, and the NSF Standard 40 test results for the Singulair 960 system with the BK device. This submission should fulfill the requirements of the Maine Rules, section 1802.3, demonstrating that the device is based on sound engineering principals.

Concerning long term certified data for the Bio-Kinetic[®] wastewater management system; as you are aware, no certifying organization has established test protocols under which the Bio-Kinetic wastewater management system can be tested. Therefore, please refer to the data provided previously from a county program.

We thank you in advance for your favorable review of our request. While the Bio-Kinetic filter has been used as the integral part of the Singulair system for more than a decade, with several hundred thousand units installed worldwide, the BK 2000 itself is a one of a kind advanced treatment system, relatively new to the conventional wastewater disposal market.

If we can provide any further information or assistance, please contact me at your convenience.

Sincerely,

NORWECO, INC

A handwritten signature in black ink, appearing to read "Joe Bush".

Joe Bush
Product Distribution Manager



FACSIMILE TRANSMISSION LETTER

DATE: April 23, 2002
TO: James A. Jacobson
FAX #: 207 287 3165
FROM: Joe Bush



SUBJECT: Request for a reduction in size of field

TOTAL NUMBER OF PAGES INCLUDING COVER:

NOTE: If you do not receive all pages, please contact our Facsimile Operator at (419) 668-4471.

COMMENTS:

Jim,

Steve Robbins asked me to fax you a copy of our request. I am sorry you did not receive the original, I will send that again. If I can be of any assistance, please call me.

Regards,
Joe Bush

NORWECO

NORWALK WASTEWATER
EQUIPMENT COMPANY
220 Republic Street
Norwalk, OH 44857-1198 U.S.A.
Phone (419) 688-4471 Fax (419) 683-5440
www.norweco.com

March 19, 2002

Mr. James A. Jacobson
Wastewater & Plumbing Control Program
Division of Health Engineering
10 State House Station
Augusta, ME 04333-0010

Dear Mr. Jacobson:

Thank you for your letter of April 9, 2001, granting the BK 2000 a 10 point value towards new system variances in the state of Maine. It is my understanding that the BK 2000 has now been used in Maine to achieve variances and to provide longevity for other new and existing systems. Meanwhile, Norweco requests that when used, the BK 2000 be granted a 20% reduction in disposal area sizing. This size reduction appears balanced with other product approvals and Section 603.0 of your Waste Water Disposal Rules.

In support of this request, we previously provided your department with documentation of successful completion of NSF Standard 46 test protocol, copies of Norweco's Singulair® 960 system without the BK device, and the NSF Standard 40 test results for the Singulair 960 system with the BK device. This submission should fulfill the requirements of the Maine Rules, section 1802.3, demonstrating that the device is based on sound engineering principals.

Concerning long term certified data for the Bio-Kinetic® wastewater management system; as you are aware, no certifying organization has established test protocols under which the Bio-Kinetic wastewater management system can be tested. Therefore, please refer to the data provided previously from a county program.

We thank you in advance for your favorable review of our request. While the Bio-Kinetic filter has been used as the integral part of the Singulair system for more than a decade, with several hundred thousand units installed worldwide, the BK 2000 itself is a one of a kind advanced treatment system, relatively new to the conventional wastewater disposal market.

If we can provide any further information or assistance, please contact me at your convenience.

Sincerely,

NORWECO, INC

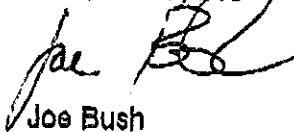

Joe Bush
Product Distribution Manager



STATE OF MAINE
DEPARTMENT OF HUMAN SERVICES
DIVISION OF HEALTH ENGINEERING
10 STATE HOUSE STATION
AUGUSTA, MAINE
04333-0010

ANGUS S. KING, JR.
GOVERNOR

April 9, 2001

KEVIN W. CONCANNON
COMMISSIONER

Norweco
Attn.: Donald S. Bach, Vice President
220 Republic Street
Norwalk, OH 44857-1196

Subject: Product Registration, Norweco Bio-Kinetic Wastewater Management System BK 2000

Dear Mr. Bach:

Thank you for your letter dated March 22, 2001 regarding your company's product. The Norweco Bio-Kinetic Wastewater Management System BK 2000 (BK 2000) is a self-contained plate filter installed between a treatment tank and the point of final effluent disposal. According to the information you provided, the BK 2000 is able to attenuate peak flows, and significantly reduce BOD₅ and TSS levels (ref.: Wilks property data sheet). You have requested that the BK 2000 be allowed 10 points toward first time variances, pursuant to Table 1900.11 of the Maine State Plumbing Code, Subsurface Wastewater Disposal Rules.

Under provisions of Section 1802 of the Maine State Plumbing Code, Subsurface Wastewater Disposal Rules any manufacturer or distributor submitting a new product for code registration needs to demonstrate that:

1. The product is designed to protect public health, prevent the creation of any nuisance, and prevent environmental pollution to the same extent as comparable products presently authorized by Department for use in this code, and
2. The product is based on sound engineering principles and can be expected to provide the same level of protection to public health and the environment as offered by the authorized products presently authorized by the Department for use in this code.

According to the information you provided, the BK 2000 has received NSF Standard 46 approval. On that basis, the Division has determined that the BK 2000 is acceptable for use in the State of Maine, provided that it is installed, operated, and maintained in conformance with the manufacturer's directions. Regarding points from Table 1900.11, the points are allowed on a performance basis, not on a per-brand or model basis, and no special permission is required to do so-only supporting data. Therefore, you may wish to collect more data than that in the Wilks' data sheet to support your product. In the meantime, 10 points is a reasonable allowance.

Because installation and owner maintenance has a significant effect on the working order of onsite sewage disposal systems, including their components, the Division makes no representation or guarantee as to the efficiency and/or operation of Norweco Bio-Kinetic Wastewater Management System BK 2000. Further, registration of this product for use in the State of Maine does not represent Division endorsement, preference, or recommendation for this product over similar products.

If you have any questions please feel free to contact me at (207) 287-5695.

Sincerely,

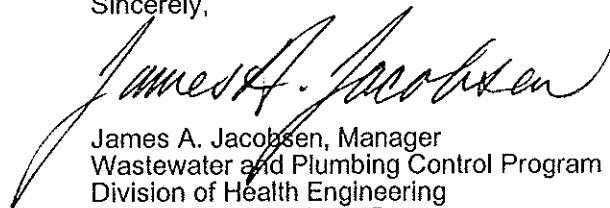

James A. Jacobsen, Manager
Wastewater and Plumbing Control Program
Division of Health Engineering
e-mail: james.jacobsen@state.me.us

xc: Product File



STATE OF MAINE

NORWECO

NORWALK WASTEWATER
EQUIPMENT COMPANY
220 Republic Street
Norwalk, OH 44857-1196 U.S.A.
(419) 668-4471 Fax (419) 663-5440

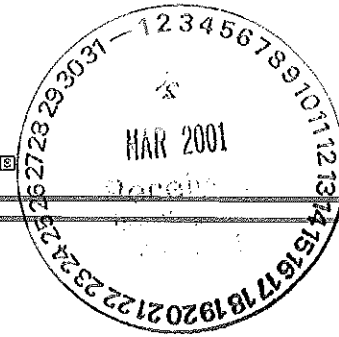

February 26, 2001

Mr. James A. Jacobsen
Manager
Wastewater & Plumbing Control Program
Division of Health Engineering
10 State House Station
Augusta, ME 04333-0010

Dear Mr. Jacobsen:

As we have discussed, and in keeping with the documentation submitted to Jay Hardcastle, Norweco requests that the Bio-Kinetic® Wastewater Management System be allowed 10 points under table 1900.11, New System Variance Request, as published in 10 CMR 241 on June 1, 2000.

In support of this request, we are providing documentation of successful completion of NSF Standard 46 test protocol, copies of Norweco's Singulair® 820 Standard 40 test results without the BK device, and the NSF Standard 40 test results for the Singulair® 960 System with the BK device. This documentation is being submitted to fulfill the requirements of section 1802.3 demonstrating that the device is based on sound engineering principals.

Concerning long term certified data for the Bio-Kinetic® Wastewater Management System; as you are aware, no certifying organization has established test protocols available under which the Bio-Kinetic® Wastewater Management System can be tested. Therefore, we are forced to provide data from county programs, one of which is included with this request.

We thank you in advance for your favorable review of our request. While the Bio-Kinetic® filter has been used as the integral part of the Singulair® System for over a decade, and several hundred thousand units are installed worldwide, the BK 2000 itself is a one of a kind advanced treatment system relatively new to the market.

If we can provide any further information or assistance, please contact me at your convenience.

Sincerely,

NORWECO, INC.

A handwritten signature in cursive script that reads "Donald A. Bach".

Donald A. Bach
Vice President/Chemical Division

DAB/ar

Enclosures

CC: Jay Hardcastle

EXPERIMENTAL SYSTEM LOG

IMS # 2312N
 Frank or Sherry Wilks
 10 S 497 Curtis Lane
 Naperville, IL 60564

| DATE | LAB # | pH | CBOD | SS | FC | CI | SAMPLER | APPEARANCE | COMMENTS |
|---------|--------|-----|------------|----|---------|------|------------|--------------|-------------------------------------|
| 4/14/00 | 180107 | 7.7 | 11.7 | 6 | <100 | 6.2 | Martinez | Clear | C12 Present |
| 5/05/00 | 171551 | 7.5 | | 0 | <100 | 11.3 | Rivenburgh | Clear | C12 Present No CBOD power outage |
| 5/26/00 | 178697 | 7.7 | 19.9 | 3 | <100 | 15.7 | Rivenburgh | Clear | C12 Present |
| 6/09/00 | 183640 | 7.6 | 19.8 | 9 | <100 | 9 | Rivenburgh | Clear | C12 Present |
| 6/30/00 | 183723 | 7.8 | Invalid ** | 5 | <100 | 3.9 | Rivenburgh | Clear | C12 Present |
| 7/21/00 | 183805 | 7.6 | Invalid ** | 8 | <100 | 2.4 | Rivenburgh | Clear | C12 Present |
| 8/11/00 | 183930 | 7.8 | 1.81 | 7 | <100 | 6.4 | Rivenburgh | Clear | C12 Present |
| 9/01/00 | 184894 | 7.3 | 10 | 16 | <20,000 | 0 | Sedgwick | Cloudy, Gray | C12 Present |

** Oxygen depletion was outside reportable limits



March 30, 2000

Mr. Michael S. Price
Norweco, Inc.
220 Republic Street
Norwalk, OH 44857

Re: ANSI/NSF Standard 46 Certification - BK Model 2000 Wastewater System
NSF Project Number 20259

Dear Mike:

I am writing to confirm the BK Model 2000 Wastewater System has met all requirements for Certification under ANSI/NSF Standard 46. These requirements include:

1. The materials, design and construction, and product literature requirements common to all products evaluated under Standard 46.
2. The performance requirements for septic tank effluent filters as given in Section 10 of Standard 46.

Please be advised, you may not place the NSF Mark on the BK Model 2000 Wastewater System until you are in receipt of your ANSI/NSF Standard 46 Official Listing.

If you have any questions, please contact me at your convenience.

Sincerely,

Richard Haffner
Business Unit Manager
Environmental & Research Services

734-769-5277 (Voice)
734-827-7123 (Fax)
haffner@nsf.org (E-mail)

cc: corporate correspondence (34030)

NORWECO.

NORWALK WASTEWATER
EQUIPMENT COMPANY
220 Republic Street
Norwalk, OH 44857-1196 U.S.A.
Phone (419) 668-4471 Fax (419) 663-5440
www.norweco.com

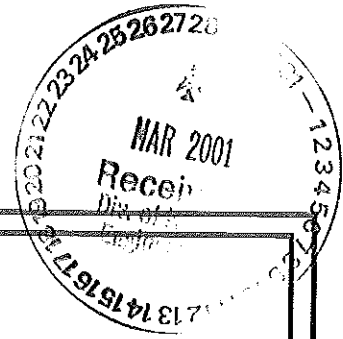

March 22, 2001

Mr. James Jacobsen
Maine Dept. of Human Services
10 State House Station
Augusta, ME 04333

- *US Bureau of the Census reports that up to 70 percent of onsite systems have failed. – US Bureau of the Census*
- *Federal Environmental Protection Agency stresses improved management programs to raise level of performance of onsite systems. – US Environmental Protection Agency*
- *Sunny Housing Market could encounter a cloudy future. – Wall Street Journal*

Dear Mr. Jacobsen:

The only certainty for the onsite industry over the next few years is that there is going to be significant changes. Upgrade of existing treatment systems to best available technology is going to be a required goal. New management programs including long-term maintenance programs will create opportunities for serviced-oriented companies. The days of system selection and installation based solely on lowest cost will be regulated to a close.

Norweco's Bio-Kinetic® Wastewater Management System is a product ideal for the present and future onsite market. Providing reliable, long-term performance for any new or existing onsite treatment system, the BK 2000 induces flow equalization to upstream tankage, filters and retains solids and chemically treats domestic effluent. Fifteen years in the making, the Bio-Kinetic® Wastewater Management System offers benefits for regulators, dealers, and the end-user.

You may have seen our Bio-Kinetic® Wastewater Management System at the recent NOWRA Conference in Michigan, and you may be considering how its benefits will improve environmental quality in your area. If not, review the enclosed brochure and log onto the Norweco website at www.norweco.com.

Our onsite field is destined to change over the next few years. Planned change is a strategy, ignoring change is a gamble. Join in Norweco's progress.

Sincerely,

NORWECO, INC.

Donald A. Bach
Vice President

Enclosures: BK 2000 Brochure
BK 2000 Drawing
Solve Onsite Problems
Response Card

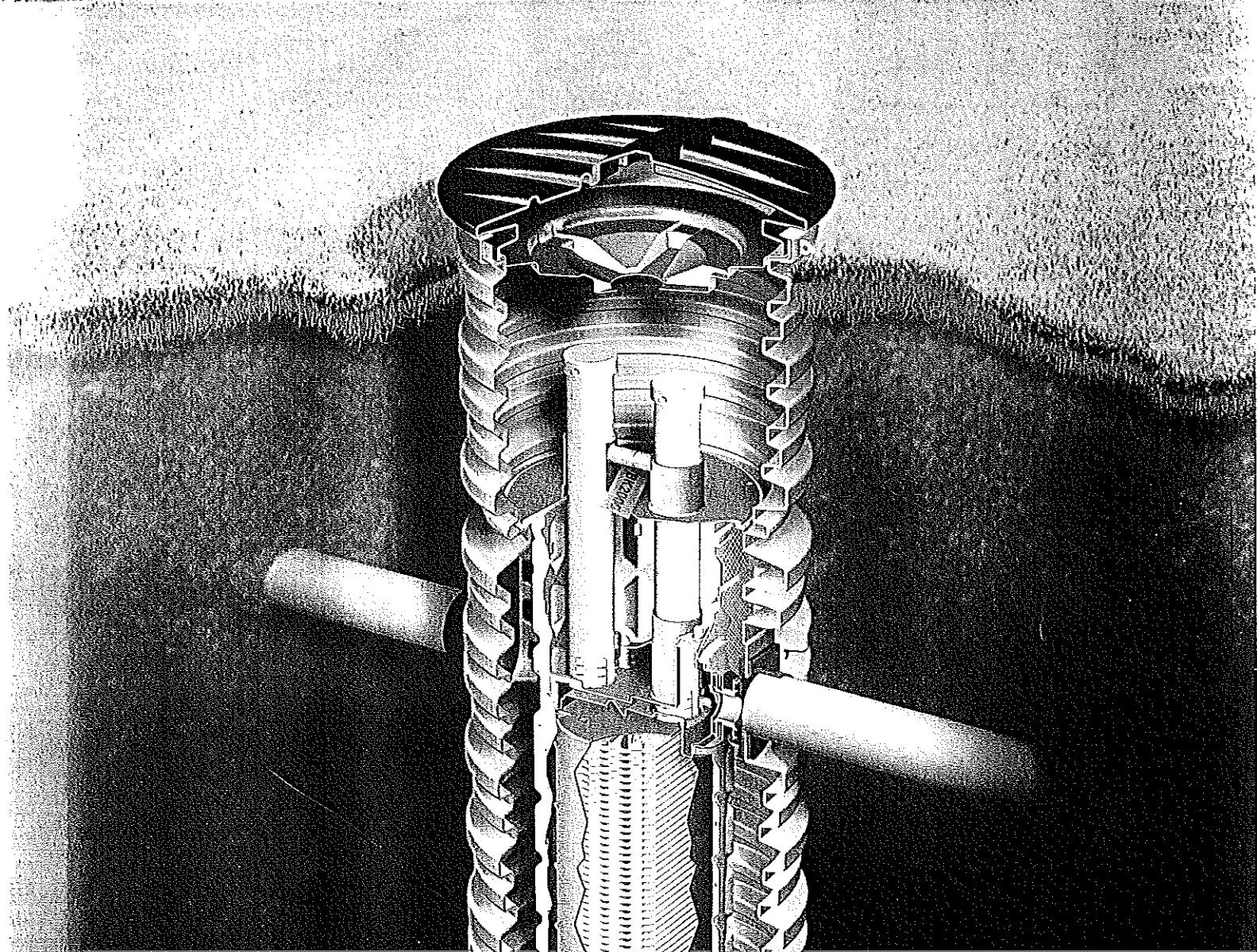
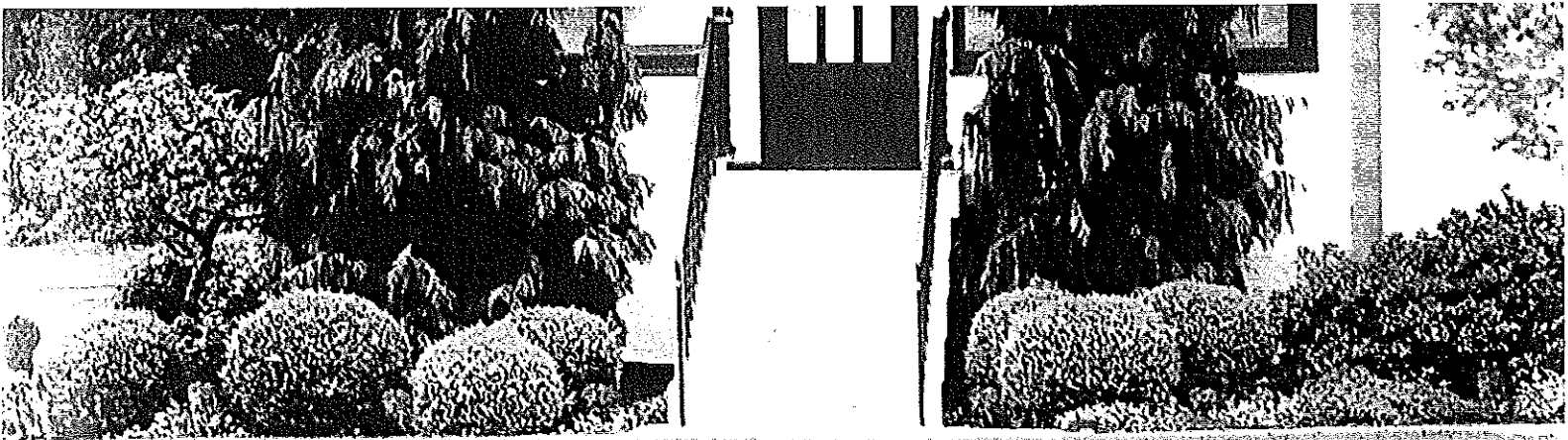

BIO-KINETIC[®]
WASTEWATER
MANAGEMENT
SYSTEM

BIO-KINETIC®



PROTECT WHAT'S MOST IMPORTANT TO YOU...

Choosing to live in a suburban or rural area without a municipal sewer no longer means having to live with the problems associated with septic tanks and filter beds. The Bio-Kinetic wastewater management system solves these problems for any application up to 2,000 gallons per day.

ADVANCED TREATMENT TECHNOLOGY FOR WASTEWATER DISPOSAL...

Conventional devices such as septic tanks, tile fields and sand filters are transformed into advanced treatment systems by the BK 2000. Filtration, settling, flow equalization, solids retention and chemical addition are proven technologies built into each management system.

HOW THE SYSTEM WORKS...

The BK 2000 manages the treatment of wastewater by keeping BOD* and solids within the treatment process. The settling and retention basin, the first of nine settling zones, retains BOD and suspended solids that would normally flow through conventional systems and plug filter beds. Solids remaining in the flow stream are trapped, as equalized flow passes through the multiple filtration, settling and treatment zones within the Bio-Kinetic tertiary device.

MAKES ANY SEPTIC SYSTEM, TILE FIELD OR FILTER BED WORK BETTER AND LAST LONGER...

Increasing the efficiency of septic tanks, tile fields and other treatment systems, the BK 2000 permanently reduces loading to downstream processes. This reduction in loading multiplies the effectiveness of any treatment system and maximizes its useful life. The BK 2000 is installed in front of tile fields, sand filters, mounds, irrigation systems, constructed wetlands or any process that is biologically sensitive, hydraulically sensitive or difficult to replace.

SOLVES A BROAD RANGE OF WASTEWATER TREATMENT AND DISPOSAL PROBLEMS...

Without a way to manage operational problems, conventional treatment systems are prone to failure. Wastewater treatment is complex and requires managing conditions such as marginal soils, high water tables, bedrock, seasonal heavy rain and hydraulic or organic overloads. Only the BK 2000 combines filtration, BOD removal, solids retention, flow equalization, optional chemical addition and simplified maintenance to provide the solution for trouble free, long-term performance.

OPERATIONAL PROTECTION AND RELIABILITY THAT INSURE A SAFE, SANITARY HOME ENVIRONMENT...

When a Bio-Kinetic wastewater management system is installed, no one has to worry about the performance of the septic tank or disposal system. The simple solution for complex problems, it is the clear choice for properly managing wastewater treatment and disposal.

With this unique combination of advanced treatment technologies and ease of installation and maintenance, the Bio-Kinetic wastewater management system protects your home, your family and the environment.



FEATURES AND ADVANTAGES

Homeowner or User

- No electricity required and no moving parts
- Easily serviced and maintained
- Eliminates costly system replacement
- Enhances property value

Engineer or Designer

- Economical upgrade to advanced treatment
- State-of-the-art wastewater management
- Extends operating life of any treatment system
- Parallel systems expand capacity above 2,000 GPD

Professional Contractor

- Economical to install
- Simplified installation eliminates errors and delays
- Readily adaptable to any site condition

Health Officials and Community

- Eliminates nuisances and public health hazards
- Prevents expensive failures in marginal soils
- Protects disposal systems, filter beds and mounds

ADVANCED WASTEWATER

1. Heavy Duty Access Cover

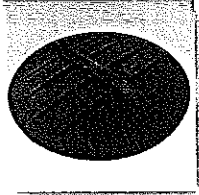

The access cover securely interlocks with the top rib of the settling and retention basin. The cover is available in either black or green to

blend nicely into any landscape.

2. Design Flow and Peak Flow Filter Media

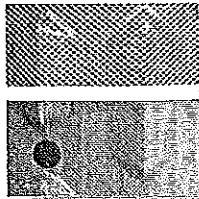

Molded filter media holds BOD and solids within the settling and retention basin. The design and peak flow filters are easily cleaned

and function for the life of the system.

3. Baffled Perimeter Settling Zone

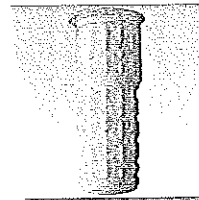

Positioned immediately downstream of the molded filter media, the baffled perimeter settling zone is the second of nine

settling zones within the BK 2000.

4. Flow Deck with Adjustable Outlet Weir

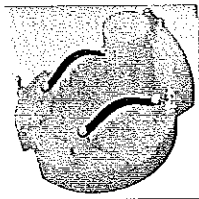

The flow deck is downstream of the six flow ports. Liquids entering as well as exiting the Bio-Kinetic tertiary treatment device are held,

controlled and directed by the flow deck.

5. Compartmented Settling Zone

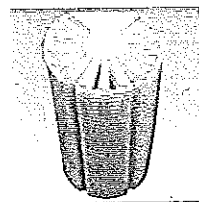

Containing 37 chamber plates and 280 feet of kinetic filtration, this settling zone establishes a multidirectional plug flow path

through the Bio-Kinetic device.

6. Removable Moisture/Vapor Shield

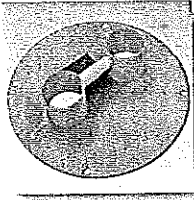

A shield prevents condensation from entering the Bio-Kinetic device. Built-in collars secure the optional chemical feed tubes.

8. Safety/Service Guard

Located beneath the access cover, the safety/service guard prevents accidental entry into the basin and is used during routine service of the wastewater management system.

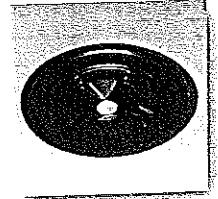

9. Quick Disconnect with Anti-Shear Inlet and Outlet

Hubs on the inlet and outlet provide a 4" socket for Schedule 40 PVC pipe. A watertight connection and simple installation and removal are assured by a quick disconnect coupling.

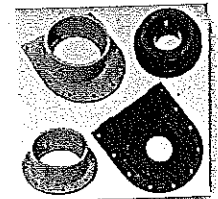

10. Lockable Compression Clamp

Access covers, risers and ring sections are each locked in position by a molded compression clamp. The clamp is secured by a stainless steel fastener or optional padlock.

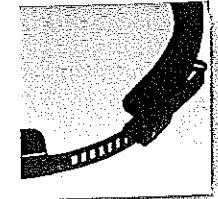

11. Gasketed Rings and Extension Risers

Rings and risers are available for installation where additional basin capacity or depth is needed. Risers are available from 6" to 72" in height, as required, for deeper installations.

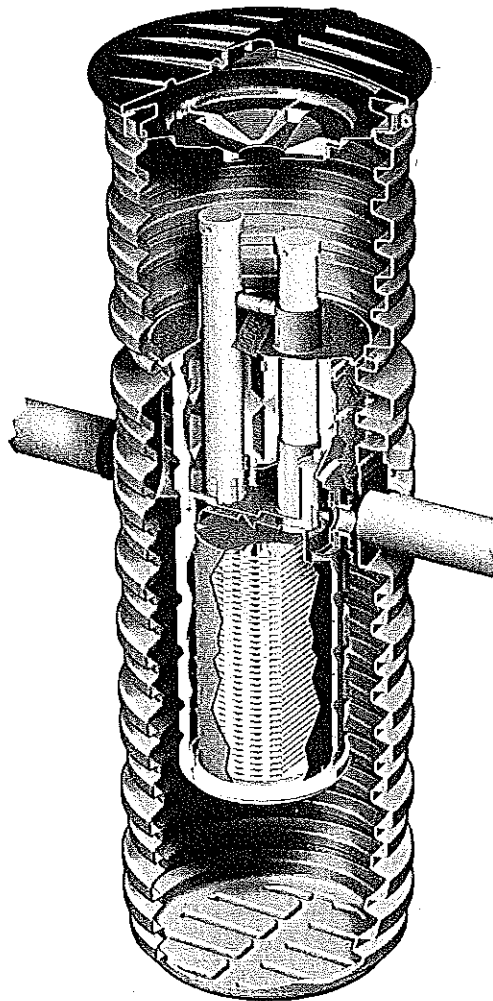
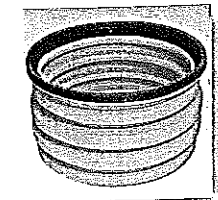

U.S. and Foreign Patents
Granted and Pending

7. Settling and Retention Basin

The settling and retention basin is constructed of corrosion resistant polyethylene. Riser and ring sections may be added to increase liquid and solids storage capacity.

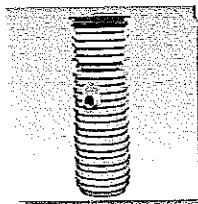

12. Self-Contained Chemical Feed System

Blue Crystal and Bio-Neutralizer feed tubes can be easily added to the flow deck of the Bio-Kinetic tertiary device to safely disinfect or dechlorinate the wastewater flow.

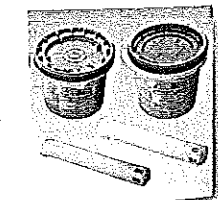

MANAGEMENT SYSTEM

PATENTED BIO-KINETIC® DEVICE DELIVERS UNMATCHED FILTRATION CAPABILITY...

The Bio-Kinetic device contains three filtration zones, eight settling zones, 37 baffled chamber plates and 280 lineal feet of kinetic filtration. These features dramatically reduce loading on downstream treatment and disposal systems.

MULTIPLE INDEPENDENT SETTLING ZONES MAXIMIZE SOLIDS REMOVAL...

The settling zones within the Bio-Kinetic device work in conjunction with filtration and equalization to effectively retain BOD and solids removed from the flow stream.

FLOW EQUALIZATION PLAYS A VITAL ROLE IN WASTEWATER TREATMENT AND DISPOSAL...

Heavy usage periods and hydraulic surges caused by clothes washers, dishwashers, water softeners, garbage disposals, baths and hot tubs are managed by six individual flow equalization ports that utilize upstream tank capacity. Two design flow ports are located at the normal liquid level of the treatment process.

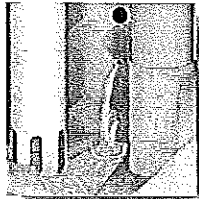

**SUSTAINED
FLOW**

The design flow ports manage daily flow variations and control flow through all upstream and downstream treatment processes.

Longer hydraulic surges will cause the liquid level to rise to a pair of sustained flow ports. Flow through the Bio-Kinetic device increases while flow equalization is maintained. Two peak flow ports manage flow during prolonged surges. With a Bio-Kinetic device in place, any treatment system will function effectively, even during periods of peak hydraulic or organic loading.

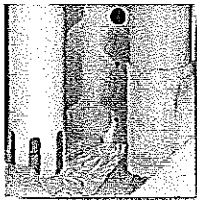

DESIGN FLOW

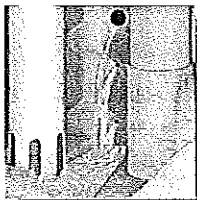

PEAK FLOW

SELF-CONTAINED TABLET FEED SYSTEM DISPENSES POTENT CHEMICAL DOSE...

Chemical treatment relies on a proper dose for maximum efficiency. The Bio-Kinetic chemical feed system insures an effective chemical application for disinfection, dechlorination, and other advanced treatment requirements.

AUTOMATICALLY DOUBLES SYSTEM PERFORMANCE AND OPERATIONAL LIFE...

The BK 2000 doubles treatment effectiveness by eliminating solids washout and hydraulic overloads, creating an efficient treatment system that will function properly for decades.

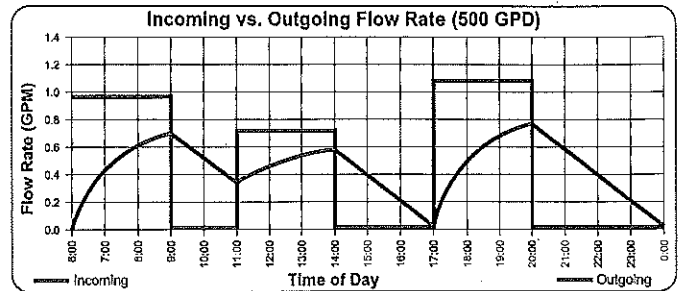

UNIQUE DESIGN UTILIZES RESERVE CAPACITY IN ANY NEW OR EXISTING SYSTEM...

The design of the BK 2000 allows any conventional wastewater treatment system to fully utilize upstream tank capacity to store and treat accumulated wastewater.

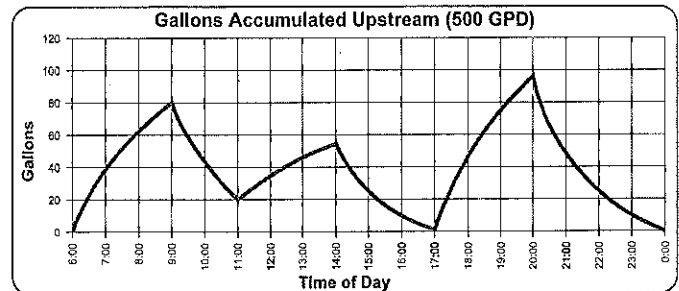

REDUCES HYDRAULIC AND SOLIDS LOADING RATES BY MORE THAN 50%...

With flow equalization, the hydraulic flow to the system is not the flow through the system. As illustrated below, the Bio-Kinetic wastewater management system equalizes flows up to 2,000 gallons per day by more than 50%.

| INPUT | | | |
|--------------------|--------------------------|-------------------------|-----------------------|
| Average Daily Flow | Minutes of Incoming Flow | Avg. Incoming Flow Rate | Upstream Surface Area |
| 500 GPD | 540 | 0.926 GPM | 50 sq. ft. |
| 1000 GPD | 540 | 1.852 GPM | 60 sq. ft. |
| 1500 GPD | 540 | 2.778 GPM | 70 sq. ft. |
| 2000 GPD | 540 | 3.704 GPM | 80 sq. ft. |
| OUTPUT | | | |
| Average Daily Flow | Minutes of Outgoing Flow | Avg. Outgoing Flow Rate | Flow Equalization |
| 500 GPD | 1094 | 0.457 GPM | 50.6% |
| 1000 GPD | 1229 | 0.814 GPM | 58.0% |
| 1500 GPD | 1295 | 1.158 GPM | 58.3% |
| 2000 GPD | 1362 | 1.468 GPM | 60.3% |

MODEL BK 2000

Serves a wide variety of wastewater applications

with unlimited design and installation flexibility

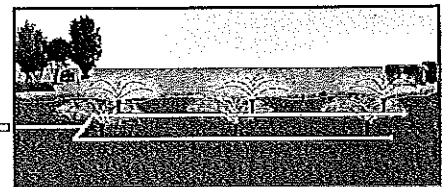
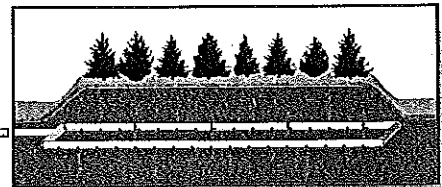
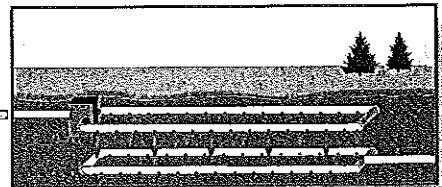
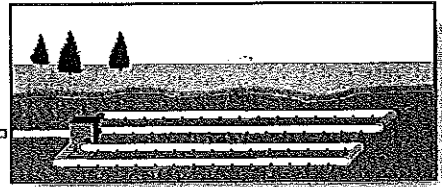
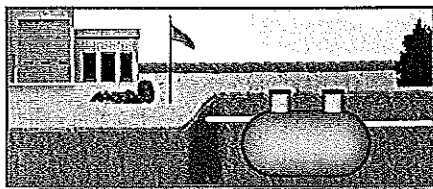
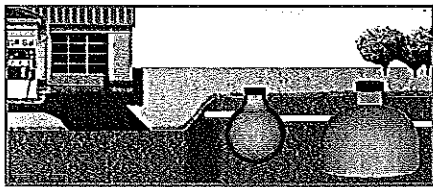
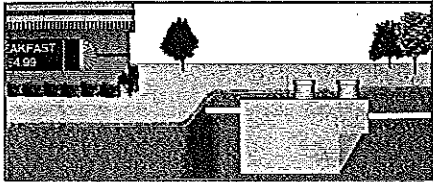
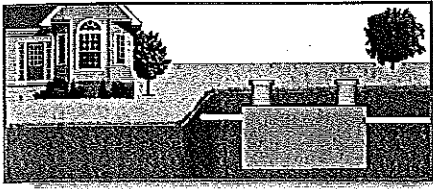

INSTALLS IN HOURS, PROVIDES BENEFITS FOR A LIFETIME...

The Bio-Kinetic wastewater management system can be easily installed as part of any wastewater treatment system. An area large enough to accommodate the retention basin and connecting piping is the only excavation required. The compact, easily transported basin is equipped with built-in connections for inlet and outlet piping, allowing installation to be completed in just a few hours. Extensive excavation work and revisions to existing landscaping are not required. There are no complex piping connections or electrical hookups. The BK 2000 and its advanced treatment features begin working immediately. The non-corrosive settling and retention basin and Bio-Kinetic tertiary device will deliver a lifetime of service and protection.

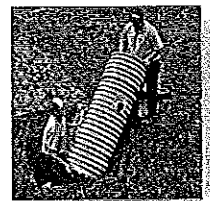

QUICK AND EASY MAINTENANCE PROTECTS YOUR INVESTMENT AND THE ENVIRONMENT...

Unlike conventional disposal systems that are not easily accessible, the BK 2000 is maintained from grade. A tank pumping truck, backhoe and confined space entry equipment are not required for routine inspections. Ground level access keeps service time to a minimum. The lockable cover prevents unauthorized access and the safety/service guard prevents accidental entry. Typical inspection patterns may vary, but normal frequency is at least once per year. Inspections may be incorporated into a pre-arranged service contract that includes maintenance as needed, available through your local dealer, distributor, or their authorized agent.

AT YOUR SERVICE – CUSTOMER SUPPORT AND PROTECTION...

Wastewater management is a critical part of the development of suburban real estate. Treatment system failures cause problems that are expensive to repair. With so much at stake, quality, reliability and customer service must be an important part of any decision regarding the type of treatment and disposal system used. The BK 2000 is a quality product backed by a local expert, manufactured, sold, installed and serviced with pride. The Bio-Kinetic wastewater management system is an advanced approach to wastewater treatment and a guardian of property value, public health and the environment.



TEN YEAR LIMITED WARRANTY

The Bio-Kinetic wastewater management system is warranted against defects in material and workmanship under normal use and service for a period of ten years. The limited warranty provides comprehensive, single source protection and covers all components of the BK 2000, including retention basin, ring sections, safety/service guard, access cover, system mounting casting, extension risers and Bio-Kinetic tertiary device. Complete warranty information, a warranty registration card and Owner's Manual are included with the purchase of each BK 2000. Detailed instructional materials and a ten year limited warranty provide Bio-Kinetic wastewater management system owners years of trouble-free operation and service.



NORWECO.
NORWALK WASTEWATER EQUIPMENT COMPANY

220 REPUBLIC STREET
NORWALK, OHIO, USA 44857-1196
TELEPHONE (419) 668-4471
FAX (419) 663-5440
www.norweco.com

Distributed Locally By:

PROGRESS THROUGH SERVICE SINCE 1906

**NSF International**

Ann Arbor, MI • Sacramento, CA • Washington, D.C. • Brussels, Belgium

March 30, 2000

Mr. Michael S. Price
Norweco, Inc.
220 Republic Street
Norwalk, OH 44857

Re: ANS/NSF Standard 46 Certification - BK Model 2000 Wastewater System
NSF Project Number 20259

Dear Mike:

I am writing to confirm the BK Model 2000 Wastewater System has met all requirements for Certification under ANS/NSF Standard 46. These requirements include:

1. The materials, design and construction, and product literature requirements common to all products evaluated under Standard 46.
2. The performance requirements for septic tank effluent filters as given in Section 10 of Standard 46.

Please be advised, you may not place the NSF Mark on the BK Model 2000 Wastewater System until you are in receipt of your ANS/NSF Standard 46 Official Listing.

If you have any questions, please contact me at your convenience.

Sincerely,

Richard Haffner
Business Unit Manager
Environmental & Research Services

734-769-5277 (Voice)
734-827-7123 (Fax)
haffner@nsf.org (E-mail)

cc: corporate correspondence (34030)

SOLVE ONSITE PROBLEMS WITH THE BK 2000

BIO-KINETIC®

WASTEWATER MANAGEMENT SYSTEM

Finally, a system that can solve the problems associated with existing domestic wastewater treatment plant failures and prevent problems from occurring in new installations. The BK 2000 has been developed to improve the performance and operating life of both new and existing septic tanks, aerobic systems, leach fields, sand filters, mounds, constructed wetlands, grease traps and oil interceptors. Utilizing advanced treatment methods, the BK 2000 protects domestic treatment plants from hydraulic surges, biosolids washout and organic overload without the use of electricity and with no moving parts. Engineers, contractors and regulators are actively searching for a means to prevent and remedy system failures associated with marginal soils, high groundwater, hydraulic or organic overload and systems past their useful lives. You can help them solve their problems. Compare these features and benefits as you evaluate the BK 2000 wastewater management system.

Provides Advanced Wastewater Treatment to Primary or Secondary Facilities, Resulting in Improved Effluent Quality, Longer System Life, Ease of Service and Environmental Protection...

- ❑ The BK 2000 removes BOD, suspended and settleable solids from wastewater and provides chemical treatment and non-mechanical flow equalization for any treatment facility. This is accomplished in a compact, easily installed and serviceable system.
- ❑ Simple sand, gravel, slotted or screened filters do not provide the advanced treatment or level of protection delivered by the BK 2000. These filters frequently plug and result in flow backing up into the home.
- ❑ Chemical treatment can be easily added to safely deliver a potent disinfectant or provide dechlorination prior to effluent discharge. The flow pattern through the eight settling zones of the Bio-Kinetic tertiary treatment device creates near plug flow conditions, thereby making sure chemicals are adequately mixed with the liquids to be treated.

Protects New as well as Existing Wastewater Treatment and Disposal Systems from Expensive Renovation or Complete Replacement...

- ❑ Treatment and disposal systems regularly fail when hydraulic surges wash out biosolids and plug the soil or filter media. The BK 2000 controls the amount of biosolids discharged from treatment tanks. Soils and filter media are protected and the proper operation of the entire treatment system is maintained.
- ❑ Expensive onsite systems (filter beds, sand filters, mounds, wetlands, evapotranspiration systems, etc.) are becoming more and more popular with designers and regulators. Unfortunately, the performance of these systems is not failsafe and replacement costs can be tens of thousands of dollars. The installation of a BK 2000 enhances system performance, protecting the owner's investment and the environment.
- ❑ The BK 2000 is easily installed as part of any new or existing treatment system, including septic tanks, aerobic systems, grease traps and oil interceptors.

Non-Mechanical, Demand Use Flow Equalization Enhances Treatment and Protects the Effluent Disposal System and Receiving Environment...

- ❑ Using patented, field proven technology, the BK 2000 equalizes flow through all treatment and effluent disposal stages. Daily residential flow can be equalized an average of 50%. No other system delivers such a high percentage of flow equalization without pumps, float switches, control valves and complex electrical controls.
- ❑ When flow into the BK 2000 increases, the flow equalization automatically increases, insuring that the design detention time for all upstream and downstream processes is maintained. With a BK 2000 in place, any onsite system can function effectively even during periods of peak hydraulic or organic loading.
- ❑ Many onsite systems fail because they are not equipped with a means to equalize flow. Everyday surges in flow can cause tanks to discharge raw sewage and biosolids that eventually make soils and other treatment media unusable. The BK 2000 eliminates solids washout by regulating the wastewater flow through the system, protecting receiving environments and ensuring long-term performance.

Easily Installed in Existing or New Domestic Treatment Plants to Solve and Prevent Problems...

- ❑ BK 2000 basins and accessories are manufactured from easy to handle, corrosion resistant, UV stabilized polyethylene. Inlets and outlets are built-in and will accept 4" diameter schedule 40 PVC pipe.
- ❑ The BK 2000 basin is a watertight, one-piece unit. If special shipping considerations apply or a riser is required, all joints in the basin are sealed watertight with a gasket and clamp. The heavy duty, one-piece access cover blends nicely into any landscape.
- ❑ When upgrading onsite systems, the existing tankage and effluent sewer line do not have to be abandoned. An excavation large enough to accept the BK 2000 basin for connection to the existing inlet and discharge piping is all that is required.

GENERAL NOTES:

- ① FALL THROUGH THE BIO-KINETIC® WASTEWATER MANAGEMENT SYSTEM IS ONE INCH FROM INLET INVERT TO OUTLET INVERT.
- ② FINISHED GRADE MUST BE MAINTAINED AT LEAST 3 INCHES BELOW THE MOISTURE DRIP LIP OF THE ACCESS COVER.
- ③ USE SAND OR FINE GRAVEL TO BACKFILL EVENLY AROUND THE BIO-KINETIC® WASTEWATER MANAGEMENT SYSTEM.
- ④ ON DEEPER INSTALLATIONS, RISERS MUST BE USED TO EXTEND THE MOUNTING CASTING TO GRADE.
- ⑤ WHEN ADDITIONAL HOLDING CAPACITY IS REQUIRED, RING SECTIONS CAN BE ADDED TO INCREASE THE DEPTH OF THE SETTLING AND RETENTION BASIN.
- ⑥ DIMENSIONS SHOWN ARE BASED ON A STANDARD BK 2000 BASIN. SEGMENTED BASINS AND BASINS CONTAINING RINGS OR RISERS WILL REQUIRE ADJUSTMENT.

PROJECT ENGINEER'S APPROVAL:
 I (WE) HEREBY CERTIFY THAT THIS DRAWING HAS BEEN CHECKED AND IS APPROVED FOR USE IN CONFORMITY WITH THE CONTRACT DOCUMENTS.
 DATE: _____
 NAME: _____

CONTRACTOR'S CERTIFICATION:
 I (WE) HEREBY CERTIFY THAT THIS DRAWING HAS BEEN CHECKED AND IS APPROVED FOR USE IN CONFORMITY WITH THE CONTRACT DOCUMENTS.
 DATE: _____
 NAME: _____

CRITICAL DIMENSIONS

| | | | |
|---|-----------|---|--|
| A | 3'-4 3/4" | J | |
| B | 3'-3 3/4" | K | |
| C | 5'-7 1/2" | L | |
| D | 0'-6 1/2" | M | |
| E | 2'-2 1/2" | N | |
| F | 2'-0" | O | |
| G | 2'-0 1/2" | P | |
| H | 6'-4 1/2" | Q | |
| I | | R | |

TOLERANCES
 NOMINAL DIMENSIONS ARE SHOWN AND MAY VARY ± 3/8" IN LENGTH FOR EACH COMPONENT.

U.S. FOREIGN PATENTS PENDING

NOTICE
 ALL RIGHTS RESERVED
 BIO-KINETIC® WASTEWATER MANAGEMENT SYSTEM

U.S. PATENT NO. 5,440,000
 J.M.H.
 5-4-00
 NTS
 PC-5-9823

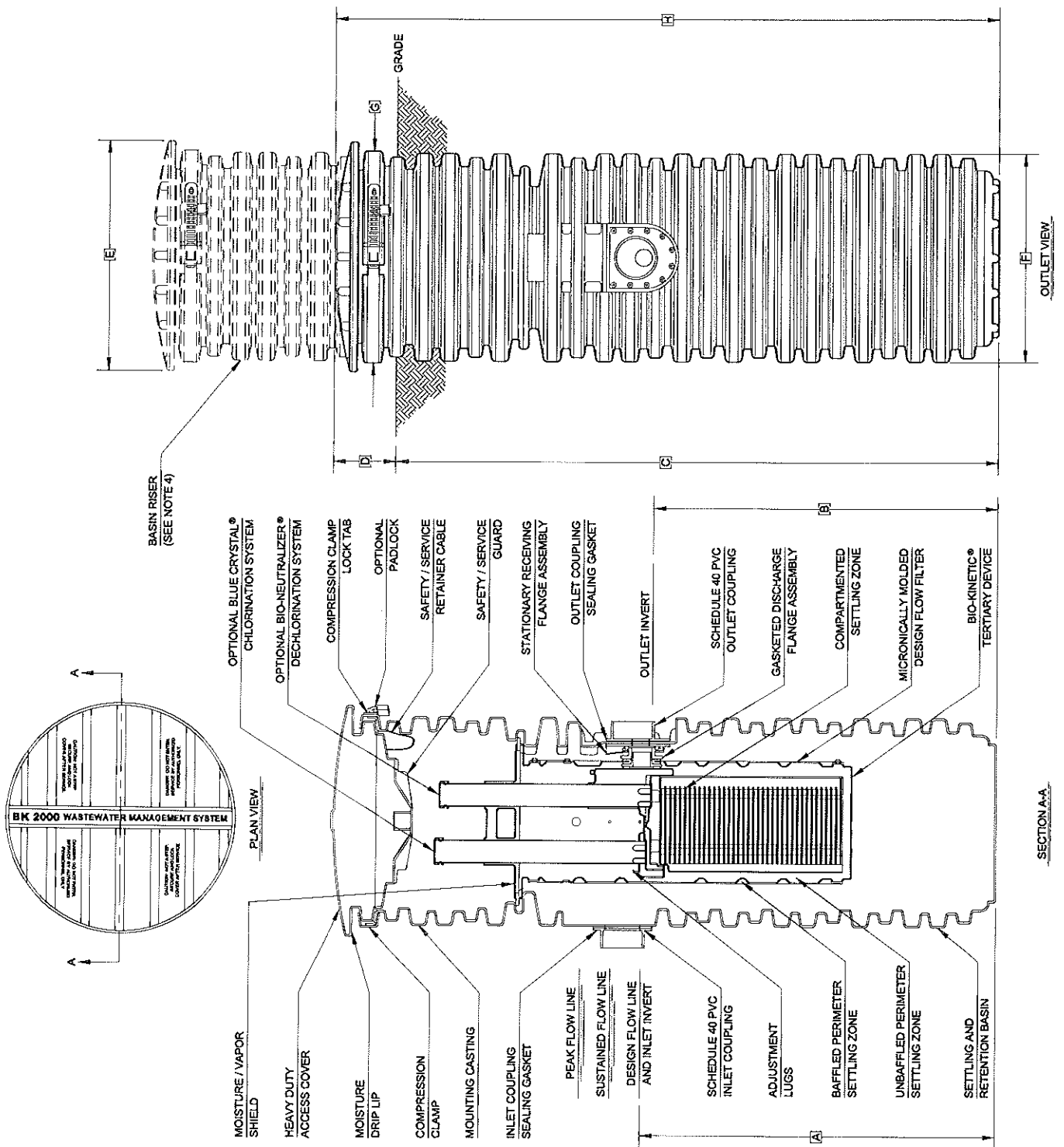

NORWECO.

NORWALK WASTEWATER
EQUIPMENT COMPANY
220 Republic Street
Norwalk, OH 44887-1198 U.S.A.
(419) 688-4471 Fax (419) 683-9410

February 9, 2001

Mr. Jay Hardcastle
State of Maine
Division of Health Engineering
10 State House Station
Augusta, ME 04333

Dear Jay:

Regarding the "straight face" data that you requested through Steve Robbins in your February 7th telephone conference, this request is more difficult to fulfill than it seems. Formal ANSI/NSF test protocol do not exist for advanced filtration/biological units such as the Bio-Kinetic[®] Wastewater Management System. Following is an initial selection of data.

First is the test protocol for NSF Standard 46 testing, which as the attached details show, has been passed. Please note in this documents that no solid greater than .48 cm can exit the system.

Second is field data from a six month test performed by the Will County Health Department outside of Chicago, Illinois. For this test, our BK 2000 follows a forty year old home treatment system that was inoperable.

Third is a literature piece that we prepared at Norweco. This literature is based on thousands of test results that we have accumulated at NSF and in the field.

Thank you for your time and willingness to evaluate our request, I remain at your disposal to provide any further data or information that you may require.

Sincerely,

NORWECO, INC.

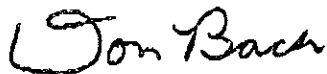

Donald A. Bach
Vice President/Chemical Division

DAB/ar

Enclosures

STD 46
(CONT)

2 of 3

NSF/46-1997

© 1999 NSF

above the bottom of the 10.2 cm (4-in) outlet pipe shall be clogged 100%.

— If the septic tank filter is designed in such a way that no filter pores are located at a point higher than 5.1 cm (2 in) above the bottom of the outlet of the test chamber, then the 85% clogging shall be conducted over the entire filter surface.

The clogged filter shall then be installed on the test chamber as shown in figure 1 according to the manufacturer's directions, and the test chamber shall be filled with tap water to the bottom of the 10.2 cm (4-in) outlet pipe. At this point the initial water level in the test chamber shall be measured and recorded. A continuous flow of tap water shall then be delivered to the test chamber until the Minimum Flow for Clogged Conditions (MFCO) is attained downstream of the septic tank filter. After an equilibrium flow condition is established, the final water level in the test chamber shall be measured.

NOTE — The MFCO is the minimum flow criteria (measured as gal/min) for septic tank filters when tested according to the conditions described in section 10.4.2. This flow rate is the product of the manufacturer's rated daily hydraulic capacity of the filter (between 1514 L/day (400 gal/day) and 5678 L/day (1500 gal/day)) and a multiplication factor of 0.00334. The 0.00334 factor is based on a stress condition in which 60% of the daily hydraulic capacity of the septic tank filter is passed through the filter during a 3-hour period (i.e. 60% / 3 hours / 60 minutes = 0.00334).

10.4.3 Structural Integrity test

A septic tank filter shall be tested for structural integrity according to the procedures described in sections 10.4.3.1 through 10.4.3.3 and evaluated to the applicable criteria described in section 10.5.

10.4.3.1 While the test chamber (figure 1) is void of any water, all removable parts, such as filters, shall be removed from the assembly and reinstalled at least 4 times to simulate the normal stresses that the septic tank filtration device may encounter during maintenance.

10.4.3.2 While the test chamber (figure 1) is filled with water, all removable parts, such as filters, shall be removed from the assembly and reinstalled at least 4 times to simulate the normal stresses that the septic tank filtration device may encounter during maintenance.

10.4.3.3 The pores of the septic tank filter shall be covered by whatever means necessary (such as taped) to simulate a 100% clogged condition. The clogged filter shall be installed on the test chamber as shown in figure 1 according to the manufacturer's instructions. The test chamber shall be filled with water to a point that is equivalent to 30.5 cm (12 in) of head above the bottom of the outlet. This clogged condition and water level shall be maintained for 48 hours.

10.4.4 Filtration efficacy (synthetic bead test)

A septic tank filter shall be tested for the retention of solids according to the procedures described in this section and evaluated to the applicable criteria described in section 10.5.

Following the manufacturer's installation instructions, the filter shall be installed on the test chamber as shown in figure 1. 200 polystyrene spheres per gallon of the test chamber capacity shall be placed in the test chamber. The spheres shall have an outside diameter of 0.48 cm \pm 0.005 cm (3/16 in \pm 0.002 in) and a specific gravity of 1.05. Tap water shall be delivered to the test chamber at a rate of 41.8 L/min \pm 1.9 L/min (11 gpm \pm 0.5 gpm) for a minimum of 8 continuous hours per day for a total of 7 days or until the filter is 100% clogged, whichever occurs first.

10.4.5 Bypass protection test

A septic tank filter shall be tested for bypass protection according to the procedures described in this section and evaluated to the applicable criteria described in section 10.5.

The pores of the septic tank filter shall be covered to simulate a completely clogged filter. Following the manufacturer's installation instructions, the filter shall be installed in the test chamber as shown in figure 1. A 0.16 cm (1/16 in) mesh screen shall be installed downstream of the filter. 200 polystyrene spheres per gallon of the test chamber capacity shall be placed in the test chamber. The spheres shall have an outside diameter of 0.48 cm \pm 0.005 cm (3/16 in \pm 0.002 in) and a specific gravity of 1.05. Tap water shall be delivered to the test chamber to raise and maintain the water level to an elevation of 10.2 cm (4 in) above the top of the filter assembly for a minimum of 8 continuous hours per day for a total of 2 days.

NSF STD 46

1063

10 Filtration devices for residential gravity flow septic tank systems

(section 10.4.2),

10.1 Scope

This section establishes minimum requirements for gravity flow filtration devices used in the outlet flow path of residential septic tank systems, which have a rated flow capacity between 1514 L/day (400 gal/day) and 5678 L/day (1500 gal/day). These requirements deal with structural integrity of the devices and their ability to prevent the discharge of specific sized manufactured particles. Reduction of sewage parameters such as BOD₅ and TSS are not addressed in section 10.

- structural integrity test (section 10.4.3),

- filtration efficacy - synthetic bead test (section 10.4.4), and

- bypass protection test (section 10.4.5).

At the conclusion of each performance test, the septic tank filter and all assemblies shall be evaluated to the applicable criteria described in section 10.5.

10.2 Model series classification

Septic tank filters within a manufacturer's model series, of the same design and varying only in their rated capacity, may be classified according to the performance testing and evaluation of the most representative model within the series.

10.4.1 Flow test for clean filters

A clean septic tank filter shall be subjected to the flow conditions described in this section and evaluated to the applicable criteria described in section 10.5.

10.3 Definitions

10.3.1 Septic tank: A watertight receptacle that is designed and constructed to receive residential wastewater, separate solids from the liquid, provide limited digestion of organic matter, store solids and allow clarified liquid to discharge for further treatment and disposal.

The test chamber (figure 1) shall be filled with tap water to the bottom of the 4-in (10.2 cm) outlet pipe. At this point the initial water level in the tank shall be measured and recorded. A continuous flow of tap water shall then be delivered to the test chamber until a flow of $41.8 \text{ L/min} \pm 1.9 \text{ L/min}$ ($11 \text{ gal/min} \pm 0.5 \text{ gal/min}$) is measured downstream of a completely assembled septic tank filtration device. After an equilibrium flow condition is established the final water level in the test chamber shall be measured.

10.3.2 Septic tank filter: A gravity flow device (including all assemblies and components) designed to enhance the retention of solids in a residential septic tank systems.

10.4.2 Flow test for partially clogged filters

A partially clogged septic tank filter shall be subjected to the flow conditions described in this section and evaluated to the applicable criteria described in section 10.5.

10.4 Performance testing and evaluation of septic tank filters

A single septic tank filter, shall be installed on the test chamber (figure 1) in accordance with the manufacturer's directions. The test chamber shall be designed and constructed so that performance testing conditions (for example: flow conditions, head pressures, and suspension of polystyrene spheres) described in sections 10.4.1 through 10.4.5 can be attained. The septic tank filter shall then be subjected to each of the following performance tests in the sequence shown:

The filter pores of the septic tank filter shall be covered by whatever means necessary (such as taped) to simulate an 85% clogged condition. Since the design of filters can vary, clogging of the filter pores shall be conducted according to the following applicable method:

- flow test for clean filters (section 10.4.1),
- flow test for partially clogged filters

- If the septic tank filter is designed in such a way that filter pores are located at a point higher than 5.1 cm (2 in) above the bottom of the outlet of the test chamber, then the clogging shall be conducted over 85% of the pores from a point 5.1 cm (2 in) above the bottom of the 10.2 cm (4 in) outlet pipe down to the lowest point of the filter. All filter pores located above a point that is 5.1 cm (2 in)

10.5 Performance requirements for septic tank filters

Septic tank filters, assemblies, and all applicable components of the device shall comply with the following applicable requirements:

- At the conclusion of each performance test (sections 10.4.1 through 10.4.5), the septic tank filter, assemblies, and all applicable components of the device shall be inspected and show no visible signs of cracking, collapse, or permanent deformation.
- After an equilibrium flow condition is established in accordance with sections 10.4.1 and 10.4.2 the final water level in the test chamber shall not exceed 5.1 cm (2 in) of head rise above the initial water level.
- At the conclusion of the 1-week solids reduction testing (section 10.4.4), the flow to the test chamber shall be shut off, and the area downstream of the septic tank filter and preceding the 0.16 cm (1/16 in) screen shall be inspected for any polystyrene spheres. There shall be zero spheres in this area of the testing device.
- At the conclusion of 48 hours of bypass protection testing (section 10.4.5), the flow to

the test chamber shall be shut off, and the area downstream of the septic tank filter and preceding the 0.16 cm (1/16 in) screen shall be inspected for any polystyrene spheres. There shall be zero spheres in this area of the testing device.

- During all stages of performance testing and evaluation (sections 10.4.1 through 10.4.5), the septic tank filter shall remain in its normal operating position. The filter shall not become dislodged as a result of flow conditions or hydraulic pressure differentials created across the filter or filter assembly.

10.6 Data plate

Septic tank filters shall have a permanent data plate attached to the device or be permanently marked with the manufacturer's name, and telephone number. This information shall be located so as to be easily seen during normal maintenance.

10.7 Final report

A final report shall be prepared that presents all data collected and observations made in accordance with the performance testing and evaluation specified in section 10.

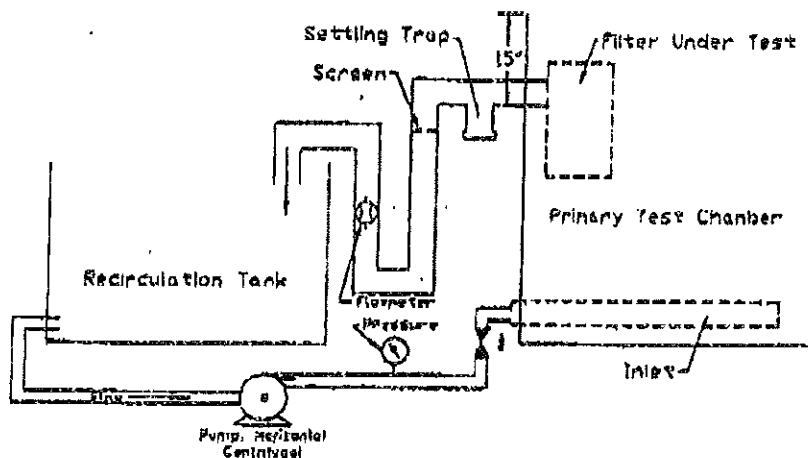

Figure 1 - Filter Test Chamber

WILL COUNTY HEALTH DEPARTMENT ENVIRONMENTAL HEALTH
LMS EFFLUENT SAMPLE RESULTS

Experimental Sample Log

Sample Address: Frank + Sherry Wilks
Mailing Address: SAME

IMSE: 231AN

Phone #: 05497 Curtis Lane
Naperville, IL 60564

FEB. 8, 2001 3:27PM NORWALK TANK: 815 726 2945 NO. 889 P. 2

| Req # | Date | pH | BOD | SS | FC # | CL | APPEAR | Collect by | Comments | COG In | Out | Lat Sent | Booze Answered |
|--------|----------|-----|------|------|-------|------|-----------------|------------|------------------------------------------------------|--------|-----|----------|----------------|
| 171551 | 5-05-00 | 7.5 | - | 0 | <100 | 11.3 | CIR | Rivabach | Cl ₂ Present, no BOD due to powder outage | | | 10/5/01 | |
| 178697 | 5-26-00 | 7.7 | 19.7 | 30 | <100 | 15.7 | CIR | Rivabach | Cl ₂ Present | | | " " | |
| 83640 | 6-9-00 | 7.6 | 19.8 | 9.0 | <100 | 9.0 | CIR | Rivabach | Cl ₂ Present | | | " " | |
| 83723 | 6-30-00 | 7.8 | 19.8 | 5.0 | <100 | 3.1 | CIR | Rivabach | Cl ₂ Present (Low BOD) | | | " " | |
| 83805 | 7-21-00 | 7.6 | 19.8 | 8.0 | <100 | 2.4 | CIR | Rivabach | Cl ₂ Present, (Low BOD) | | | " " | |
| 83930 | 8-11-00 | 7.8 | 19.8 | 7.0 | <100 | 6.4 | CIR | Rivabach | Cl ₂ Present, Effluent leak | | | " " | |
| 80107 | 9-14-00 | 7.7 | 16.7 | 6.0 | <100 | 6.2 | CIR | OM | " " Dish | | | " " | NO |
| 84894 | 9/1/00 | 7.3 | 10.0 | 16.0 | 72000 | 0.0 | Cloudy | Submitt | Cl ₂ Present cloudy pink out discharge | | | " " | Mrs |
| 89223 | 9-27-00 | 7.3 | 10.0 | 5.0 | <100 | 11.7 | Cloudy | Giraple | | | | " " | |
| 84194 | 10-5-00 | 7.6 | 3.0 | 11.0 | <100 | 2.4 | Slightly Cloudy | Submitt | Cl ₂ present | | | " " | |
| 84163 | 10-27-00 | 7.5 | 4.0 | 12.0 | <100 | 3.9 | clr | Seabrick | Cl ₂ present | | | " " | |

CRITICAL RESULTS EXPRESSED AS MG/L

WILL COUNTY HEALTH DEPARTMENT
ENVIRONMENTAL LABORATORY TEST RESULTS

I.D.P.H. Certificate # 17524
Report Date: 11/20/00

IL E.P.A. Certificate # 100209
Requisition Number: 169334

Water Supply: IMS
Sample Type: Sewage Effluent
Chlorination: Continuous
Routine

Sample Collected: 11/17/00 09:00
CCC
CATHY S KH (630)-679-7030
Sample Received: 11/17/00 14:20
Sample Bottle: Dechlorinating Agent
Sample Address Source: 2312N
10 S 497 CURTIS LANE
NAPERVILLE, IL 60564

Document #:
IMS Permit #: 2312N

FRANK OR SHERI WILKS
10 S 497 CURTIS LANE
NAPERVILLE, IL 60564 8930

| ANALYSIS | TEST DESCRIPTION | RESULT |
|-------------------|-------------------------------------------------------------------------------|--------------|
| 11/17/00 15:37 | Faecal Coliform | 100.0 /100ml |
| | Membrane Filter Method was used to analyze sample. | |
| 11/17/00 15:30 | Suspend Solids | 6.0 mg/L |
| | Standard Methods, 18th edition part 2540-D was used to analyze this sample. | |
| 11/17/00 15:27 | Chlorine Residual | > 17.7 mg/L |
| 11/17/00 15:27 | PH TEMP 16.8C | 7.3 |
| | Standard Methods, 18th edition part 4500-H,B was used to analyze this sample. | |
| 11/17/00 15:27 | CBOD (5 Day) CHLORINE CONCENTRATION TOO HIGH FOR BOD ANALYSIS | Invalid mg/L |

Comments: CLR CL2 PRES

FINAL REPORT

Reviewed By *[Signature]* *[Signature]* *[Signature]*

Chem Analyst Micro Analyst

Will County Health Department
501 Ella Avenue
Joliet, IL 60433 (815) 727-8517

The Laboratory claims responsibility for analysis only. No responsibility is assumed for specimen collection, preservation, storage, and transport. Sample results relate only to the analytes of interest tested. This report shall not be reproduced, except in full, without the written approval of the laboratory. Page 1 of 1

COPY



FACSIMILE TRANSMISSION LETTER

DATE: February 9, 2001

TO: Mr. Jay Hardcastle
State of Maine
Division of Health Engineering

FAX #: 207-287-³¹⁶⁵~~4132~~

FROM: Donald A. Bach
Vice President/Chemical Division

TOTAL NUMBER OF PAGES INCLUDING COVER: 10

NOTE: If you do not receive all pages, please contact our Facsimile Operator at (419) 668-4471.

ANSI/NSF 46 -- 2000

***Evaluation of components and
devices used in wastewater
treatment systems***

**American National Standard/
NSF International Standard**

ANSI/NSF 46 -- 2000



September 24, 1999

Norweco
Attn.: Michael S. Price, R.S.
220 Republic Street
Norwalk, OH 44857-1196

Subject: Product Registration, Norweco Bio-Kinetic Wastewater Management System

Dear Mr. Price:

Thank you for your letter dated August 16, 1999 regarding your company's product. Under provisions of Section 1902 of the Maine State Plumbing Code, Subsurface Wastewater Disposal Rules any manufacturer or distributor submitting a new product for code registration needs to demonstrate that:

1. The product is designed to protect public health, prevent the creation of any nuisance, and prevent environmental pollution to the same extent as comparable products presently authorized by Department for use in this code, and
2. The product is based on sound engineering principles and can be expected to provide the same level of protection to public health and the environment as offered by the authorized products presently authorized by the Department for use in this code.

Such demonstration may be achieved by submitting a letter to the Division of Health Engineering from: a) a certifying organization, such as from National Sanitation Foundation (NSF), Building Officials and Code Administrators (BOCA), or other suitable organization stating their approval of the product, or b) the American Society for Testing and Materials (ASTM) indicating the requested product (used as indicated in the request) meets the ASTM standard as specifically listed in the appropriate section of any nationally recognized plumbing code, such as BOCA, IAPMO (same as International Plumbing Code), or equal.

According to the information you provided, Norweco Bio-Kinetic Wastewater Management System has received Standard 40 approval NSF, as part of the Norweco Singulair System. On that basis, the Division has determined that Norweco Bio-Kinetic Wastewater Management System is acceptable for use in the State of Maine, provided that it is installed, operated, and maintained in conformance with the manufacturer's directions.

Page 2;
Norweco Bio-Kinetic Wastewater Management System

Because installation and owner maintenance has a significant effect on the working order of onsite sewage disposal systems, including their components, the Division makes no representation or guarantee as to the efficiency and/or operation of Norweco Bio-Kinetic Wastewater Management System. Further, registration of this product for use in the State of Maine does not represent Division preference or recommendation for this product over similar products.

If you have any questions please feel free to contact me at (207) 287-5695.

Sincerely,

James A. Jacobsen, Manager
Wastewater and Plumbing Control Program
Division of Health Engineering
e-mail: james.jacobsen@state.me.us

xc: Product File

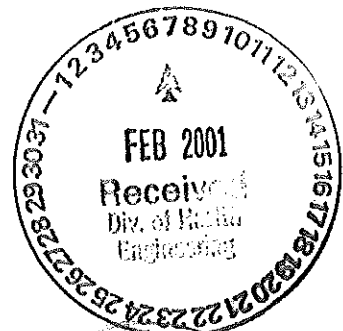

FACSIMILE TRANSMISSION LETTER

DATE: February 5, 2001

TO: Mr. Jay Hardcastle
Division of Health Engineering

FAX #: 207-287-3165

FROM: Donald A. Bach
Vice President/Chemical Division



TOTAL NUMBER OF PAGES INCLUDING COVER: 5

NOTE: If you do not receive all pages, please contact our Facsimile Operator at (419) 668-4471.

COMMENTS:

Dear Mr. Hardcastle:

Following is information that may prove useful in your evaluation. A full technical manual is being sent under separate cover.

Best regards!

**NSF International**

Ann Arbor, MI • Sacramento, CA • Washington, D.C. • Brussels, Belgium

March 30, 2000

Mr. Michael S. Price
Norweco, Inc.
220 Republic Street
Norwalk, OH 44857

Re: ANS/NSF Standard 46 Certification - BK Model 2000 Wastewater System
NSF Project Number 20259

Dear Mike:

I am writing to confirm the BK Model 2000 Wastewater System has met all requirements for Certification under ANS/NSF Standard 46. These requirements include:

1. The materials, design and construction, and product literature requirements common to all products evaluated under Standard 46.
2. The performance requirements for septic tank effluent filters as given in Section 10 of Standard 46.

Please be advised, you may not place the NSF Mark on the BK Model 2000 Wastewater System until you are in receipt of your ANS/NSF Standard 46 Official Listing.

If you have any questions, please contact me at your convenience.

Sincerely,

Richard Haffner
Business Unit Manager
Environmental & Research Services

734-769-5277 (Voice)
734-827-7123 (Fax)
haffner@nsf.org (E-mail)

cc: corporate correspondence (34030)

P.O. Box 130140 Ann Arbor, Michigan 48113-0140 USA
734-769-8010 1-800-NSF-MARK Fax 734-769-0109
E-Mail: info@nsf.org Web: http://www.nsf.org

GENERAL NOTES:

- 1. FALL THROUGH THE BIO-KINETIC WASTEWATER MANAGEMENT SYSTEM IS ONE INCH FROM INLET INVERT TO OUTLET INVERT.
- 2. FINISHED GRADE MUST BE MAINTAINED AT LEAST 9 INCHES BELOW THE MAINTAINING DROP 1/4" OF THE ACCESS COVER.
- 3. USE SAND OR FINE GRAVEL TO BACKFILL EVENLY AROUND THE BIO-KINETIC WASTEWATER MANAGEMENT SYSTEM.
- 4. ON DEEPER INSTALLATIONS, RISERS MUST BE LUSSED TO EXTEND THE MAINTAINING CASTING TO GRADE.
- 5. WHEN ADDITIONAL HOLDING CAPACITY IS REQUIRED, RWB SECTIONS CAN BE ADDED TO INCREASE THE DEPTH OF THE SETTLING AND RETENTION BASIN.
- 6. DIMENSIONS SHOWN ARE BASED ON A STANDARD BK 2000 BASIN. SEGMENTED BASINS AND BASINS CONTAINING RISERS OR RISERS WILL REQUIRE ADJUSTMENT.

PROJECT ENGINEER'S APPROVAL:
I HEREBY CERTIFY THAT THIS DRAWING HAS BEEN CHECKED AND IS APPROVED FOR USE IN CONFORMITY WITH THE CONTRACT DOCUMENTS.

DATE: _____
NAME: _____

CONTRACTOR'S CERTIFICATION:
I HEREBY CERTIFY THAT THIS DRAWING HAS BEEN CHECKED AND IS APPROVED FOR USE IN CONFORMITY WITH THE CONTRACT DOCUMENTS.

DATE: _____
NAME: _____

CRITICAL DIMENSIONS

| | |
|---|-----------|
| 1 | 3'-4 1/2" |
| 2 | 3'-9" |
| 3 | 5'-2 1/2" |
| 4 | 4'-8 1/2" |
| 5 | 2'-2 1/2" |
| 6 | 2'-4" |
| 7 | 2'-0 1/2" |
| 8 | 8'-4 1/2" |
| 9 | 1'-0" |

TOLERANCES

NOMINAL DIMENSIONS ARE SHOWN AND MAY VARY ± 1/8" IN LENGTH FOR EACH COMPONENT.

NO. 675
REV. 01
DATE: 02/05/01
PROJECT: WASTEWATER MANAGEMENT SYSTEM

NORWECO
WASTEWATER MANAGEMENT SYSTEM

SCALE: 1" = 1'-0"

PC-5-967D

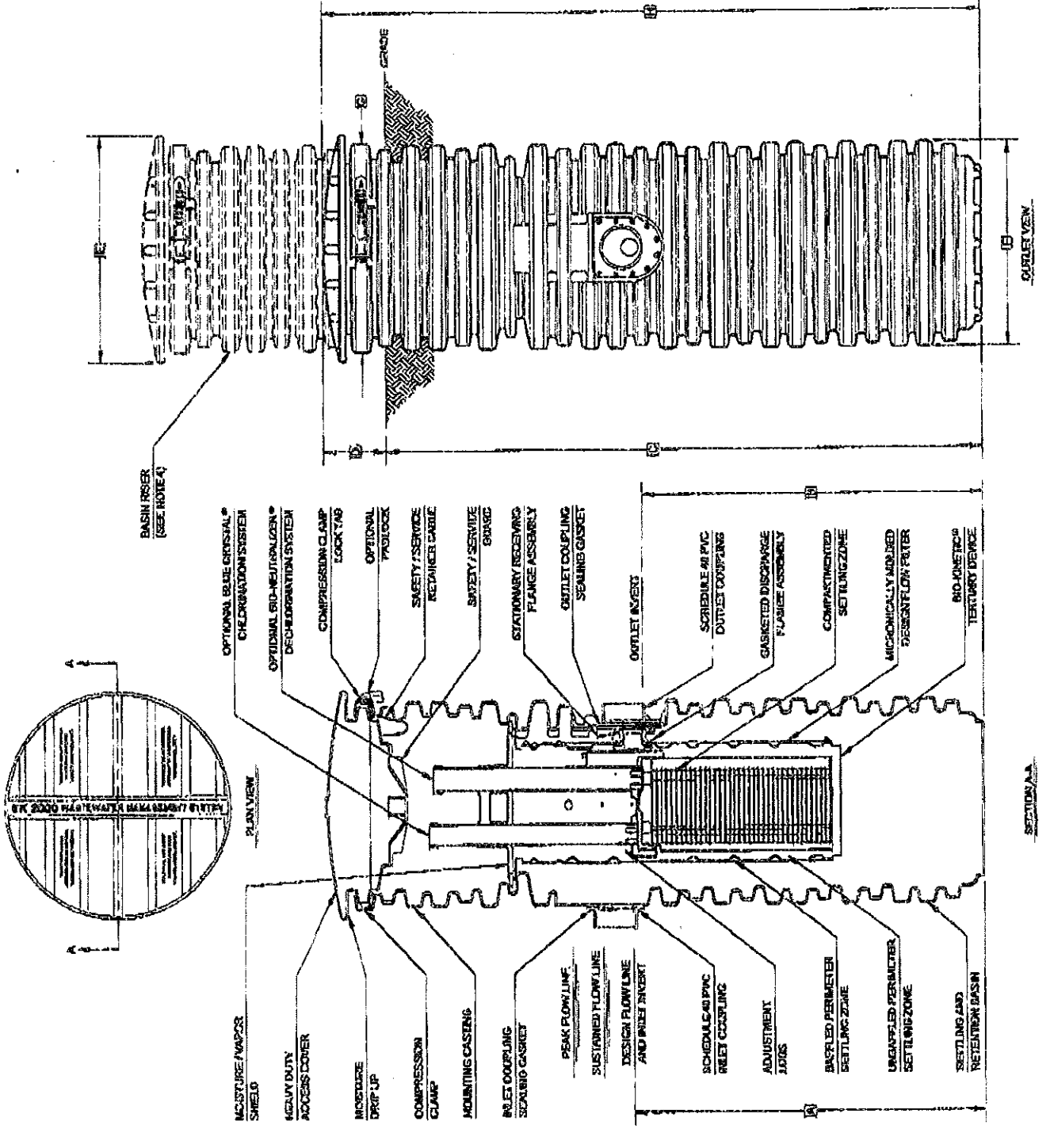

GENERAL NOTES:

- 1 TOTAL FALL THROUGH TYPICAL SEPTIC TANK AND BIO-KINETIC® WASTEWATER MANAGEMENT SYSTEM IS FOUR INCHES WHEN THE TRANSFER PIPE BETWEEN DEVICES IS INSTALLED LEVEL.
- 2 IN ORDER TO FULLY UTILIZE UPSTREAM FLOW EQUALIZATION CAPACITY, THE TRANSFER PIPE SHOULD BE INSTALLED WITH LESS THAN 1/2" OF FALL AND LESS THAN 10' OF LENGTH.
- 3 ON RISER INSTALLATIONS, RISERS MUST BE USED TO EXCEED ALL MOUNTING CASTINGS TO GRADE.
- 4 WHEN ADDITIONAL HOLDING CAPACITY IS REQUIRED, RING SECTIONS CAN BE ADDED TO INCREASE THE DEPTH OF THE SETTLING AND RETENTION BASIN.
- 5 DIMENSIONS SHOWN ARE BASED ON A STANDARD BK 2009 BASIN SEGMENTED BASINS AND BASINS CONTAINING RINGS OR RISERS WILL REQUIRE ADJUSTMENT.
- 6 THE OUTLET TEE OR BAFFLE MUST EXTEND TO WITHIN ONE INCH OF THE INSIDE TOP OF THE TANK.

PROJECT ENGINEER'S APPROVAL:
 I (WE) HEREBY CERTIFY THAT THIS DRAWING HAS BEEN CHECKED AND IS APPROVED FOR USE IN CONFORMITY WITH THE CONTRACT DOCUMENTS.
 DATE: _____
 NAME: _____

CONTRACTOR'S CERTIFICATION:
 I (WE) HEREBY CERTIFY THAT THIS DRAWING HAS BEEN CHECKED AND IS APPROVED FOR USE IN CONFORMITY WITH THE CONTRACT DOCUMENTS.
 DATE: _____
 NAME: _____

| CRITICAL DIMENSIONS | |
|---------------------|-----------|
| 1 | 6'-4 1/2" |
| 2 | 2'-5" |
| 3 | 3'-4 1/2" |
| 4 | 2'-5" |
| 5 | 2'-5" |
| 6 | |
| 7 | |
| 8 | |
| 9 | |
| 10 | |
| 11 | |

TOLERANCES
 NOMINAL DIMENSIONS ARE SHOWN AND MAY VARY ± 3/8" IN LENGTH FOR EACH COMPONENT.

| | |
|---------------------------------------------------------------------------|--------------------------------------|
| | SUB AND FOREMAN FOUND NAME NO. |
| BIO-KINETIC® WASTEWATER MANAGEMENT SYSTEM TYPICAL CONCRETE SEPTIC TANK | MTS PC-5-0803 |

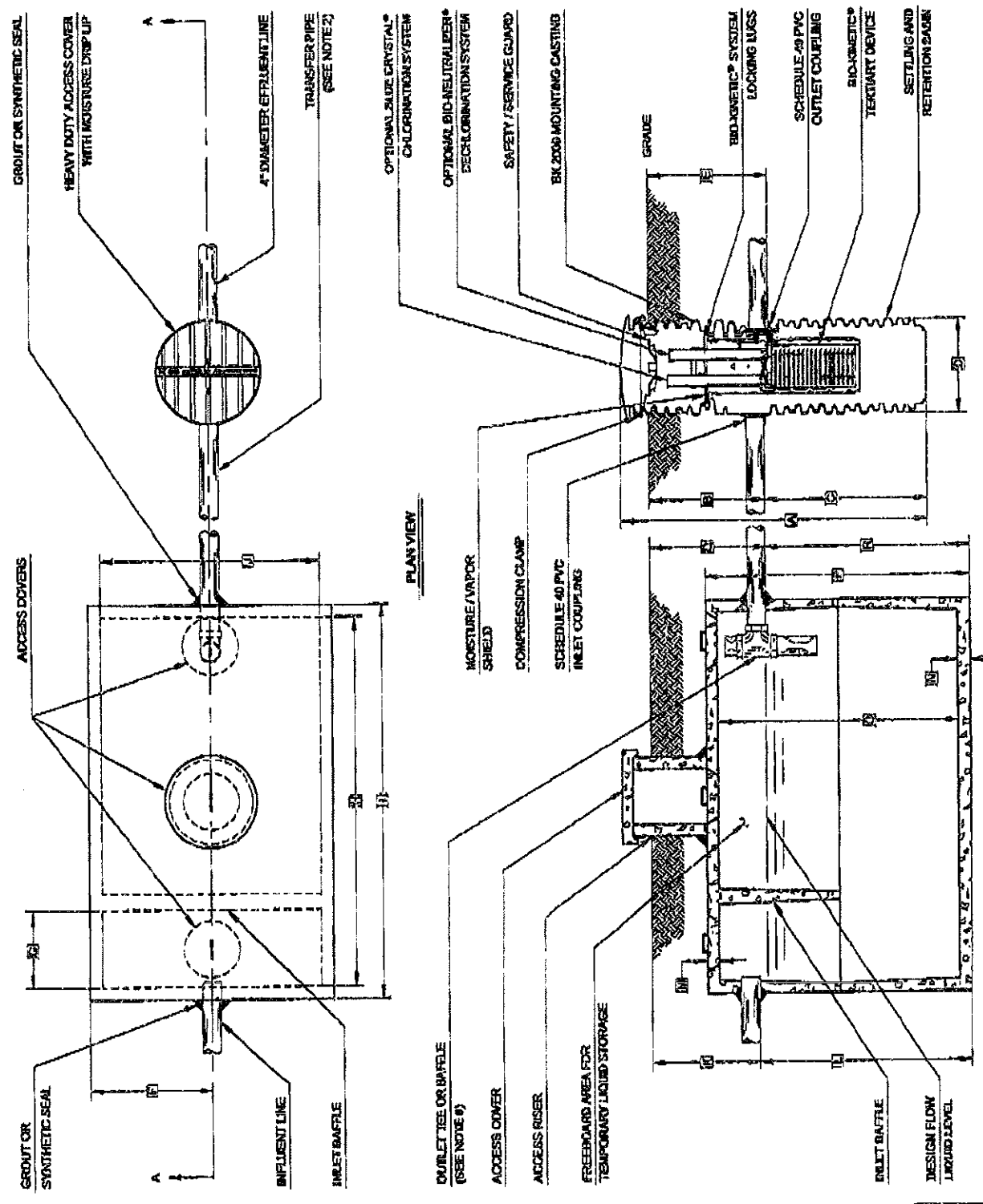

NOTE: SOME CRITICAL DIMENSIONS ARE INTENTIONALLY LEFT BLANK TO BE FILLED IN PER INDIVIDUAL JOB SITE SPECIFICATIONS.

BIO-KINETIC® WASTEWATER MANAGEMENT SYSTEM

CONCRETE SEPTIC TANK

SECTION A-A

NOTE: SEPTIC TANK MAY BE NON-COMPARTMENTED (AS SHOWN) OR WITH 2 OR MORE COMPARTMENTS.

GENERAL NOTES:

- ① TOTAL FALL THROUGH TYPICAL SEPTIC TANK AND BIC-KINETIC® WASTEWATER MANAGEMENT SYSTEM IS FOUR INCHES WHEN THE TRANSFER PIPE BETWEEN DEVICES IS INSTALLED LEVEL.
- ② IN ORDER TO FULLY UTILIZE UPSTREAM FLOW EQUALIZATION CAPACITY, THE TRANSFER PIPE SHOULD BE INSTALLED WITHOUT LESS THAN 1/2" OF HULL AND LESS THAN 10" OF LENGTH.
- ③ ON DEEPER INSTALLATIONS, RISERS MUST BE USED TO EXTEND ALL MOUNTING CASTINGS TO GRADE.
- ④ WHEN ADDITIONAL HOLDING CAPACITY IS REQUIRED, RING SECTIONS CAN BE ADDED TO INCREASE THE DEPTH OF THE SETTLING AND RETENTION BASIN.
- ⑤ DIMENSIONS SHOWN ARE BASED ON A STANDARD BIC 2000 BASIN. SEGMENTED BASINS AND BASINS CONTAINING RISERS OR RISERS WILL REQUIRE ADJUSTMENT.
- ⑥ THE OUTLET TEE OR BAFFLE MUST EXTEND TO WITHIN ONE INCH OF THE INSIDE TOP OF THE TANK.

PROJECT ENGINEER'S APPROVAL:
I (NAME) HEREBY CERTIFY THAT THIS DRAWING HAS BEEN CHECKED AND IS APPROVED FOR USE IN CONFORMITY WITH THE CONTRACT DOCUMENTS.

DATE: _____

NAME: _____

CONTRACTOR'S CERTIFICATION:
I (NAME) HEREBY CERTIFY THAT THIS DRAWING HAS BEEN CHECKED AND IS APPROVED FOR USE IN CONFORMITY WITH THE CONTRACT DOCUMENTS.

DATE: _____

NAME: _____

CRITICAL DIMENSIONS

| | | |
|-----|-----------|---|
| 1 | 6'-0 1/2" | U |
| 2 | 2'-0" | U |
| 3 | 2'-4 1/2" | U |
| 4 | 2'-0" | U |
| 5 | 2'-4" | U |
| 6 | 2'-0" | U |
| 7 | 2'-0" | U |
| 8 | 2'-0" | U |
| 9 | 2'-0" | U |
| 10 | 2'-0" | U |
| 11 | 2'-0" | U |
| 12 | 2'-0" | U |
| 13 | 2'-0" | U |
| 14 | 2'-0" | U |
| 15 | 2'-0" | U |
| 16 | 2'-0" | U |
| 17 | 2'-0" | U |
| 18 | 2'-0" | U |
| 19 | 2'-0" | U |
| 20 | 2'-0" | U |
| 21 | 2'-0" | U |
| 22 | 2'-0" | U |
| 23 | 2'-0" | U |
| 24 | 2'-0" | U |
| 25 | 2'-0" | U |
| 26 | 2'-0" | U |
| 27 | 2'-0" | U |
| 28 | 2'-0" | U |
| 29 | 2'-0" | U |
| 30 | 2'-0" | U |
| 31 | 2'-0" | U |
| 32 | 2'-0" | U |
| 33 | 2'-0" | U |
| 34 | 2'-0" | U |
| 35 | 2'-0" | U |
| 36 | 2'-0" | U |
| 37 | 2'-0" | U |
| 38 | 2'-0" | U |
| 39 | 2'-0" | U |
| 40 | 2'-0" | U |
| 41 | 2'-0" | U |
| 42 | 2'-0" | U |
| 43 | 2'-0" | U |
| 44 | 2'-0" | U |
| 45 | 2'-0" | U |
| 46 | 2'-0" | U |
| 47 | 2'-0" | U |
| 48 | 2'-0" | U |
| 49 | 2'-0" | U |
| 50 | 2'-0" | U |
| 51 | 2'-0" | U |
| 52 | 2'-0" | U |
| 53 | 2'-0" | U |
| 54 | 2'-0" | U |
| 55 | 2'-0" | U |
| 56 | 2'-0" | U |
| 57 | 2'-0" | U |
| 58 | 2'-0" | U |
| 59 | 2'-0" | U |
| 60 | 2'-0" | U |
| 61 | 2'-0" | U |
| 62 | 2'-0" | U |
| 63 | 2'-0" | U |
| 64 | 2'-0" | U |
| 65 | 2'-0" | U |
| 66 | 2'-0" | U |
| 67 | 2'-0" | U |
| 68 | 2'-0" | U |
| 69 | 2'-0" | U |
| 70 | 2'-0" | U |
| 71 | 2'-0" | U |
| 72 | 2'-0" | U |
| 73 | 2'-0" | U |
| 74 | 2'-0" | U |
| 75 | 2'-0" | U |
| 76 | 2'-0" | U |
| 77 | 2'-0" | U |
| 78 | 2'-0" | U |
| 79 | 2'-0" | U |
| 80 | 2'-0" | U |
| 81 | 2'-0" | U |
| 82 | 2'-0" | U |
| 83 | 2'-0" | U |
| 84 | 2'-0" | U |
| 85 | 2'-0" | U |
| 86 | 2'-0" | U |
| 87 | 2'-0" | U |
| 88 | 2'-0" | U |
| 89 | 2'-0" | U |
| 90 | 2'-0" | U |
| 91 | 2'-0" | U |
| 92 | 2'-0" | U |
| 93 | 2'-0" | U |
| 94 | 2'-0" | U |
| 95 | 2'-0" | U |
| 96 | 2'-0" | U |
| 97 | 2'-0" | U |
| 98 | 2'-0" | U |
| 99 | 2'-0" | U |
| 100 | 2'-0" | U |

TOLERANCES

NOMINAL DIMENSIONS ARE SHOWN AND MAY VARY ± 3/8" IN LENGTH FOR EACH COMPONENT.

| | | | | |
|-----|-------------------------|------|----|-------|
| NO. | DESCRIPTION | DATE | BY | CHKD. |
| 1 | ISSUED FOR PERMITS | | | |
| 2 | ISSUED FOR CONSTRUCTION | | | |
| 3 | ISSUED FOR RECORD | | | |
| 4 | ISSUED FOR AS-BUILT | | | |
| 5 | ISSUED FOR ARCHIVE | | | |
| 6 | ISSUED FOR OTHER | | | |
| 7 | ISSUED FOR OTHER | | | |
| 8 | ISSUED FOR OTHER | | | |
| 9 | ISSUED FOR OTHER | | | |
| 10 | ISSUED FOR OTHER | | | |
| 11 | ISSUED FOR OTHER | | | |
| 12 | ISSUED FOR OTHER | | | |
| 13 | ISSUED FOR OTHER | | | |
| 14 | ISSUED FOR OTHER | | | |
| 15 | ISSUED FOR OTHER | | | |
| 16 | ISSUED FOR OTHER | | | |
| 17 | ISSUED FOR OTHER | | | |
| 18 | ISSUED FOR OTHER | | | |
| 19 | ISSUED FOR OTHER | | | |
| 20 | ISSUED FOR OTHER | | | |
| 21 | ISSUED FOR OTHER | | | |
| 22 | ISSUED FOR OTHER | | | |
| 23 | ISSUED FOR OTHER | | | |
| 24 | ISSUED FOR OTHER | | | |
| 25 | ISSUED FOR OTHER | | | |
| 26 | ISSUED FOR OTHER | | | |
| 27 | ISSUED FOR OTHER | | | |
| 28 | ISSUED FOR OTHER | | | |
| 29 | ISSUED FOR OTHER | | | |
| 30 | ISSUED FOR OTHER | | | |
| 31 | ISSUED FOR OTHER | | | |
| 32 | ISSUED FOR OTHER | | | |
| 33 | ISSUED FOR OTHER | | | |
| 34 | ISSUED FOR OTHER | | | |
| 35 | ISSUED FOR OTHER | | | |
| 36 | ISSUED FOR OTHER | | | |
| 37 | ISSUED FOR OTHER | | | |
| 38 | ISSUED FOR OTHER | | | |
| 39 | ISSUED FOR OTHER | | | |
| 40 | ISSUED FOR OTHER | | | |
| 41 | ISSUED FOR OTHER | | | |
| 42 | ISSUED FOR OTHER | | | |
| 43 | ISSUED FOR OTHER | | | |
| 44 | ISSUED FOR OTHER | | | |
| 45 | ISSUED FOR OTHER | | | |
| 46 | ISSUED FOR OTHER | | | |
| 47 | ISSUED FOR OTHER | | | |
| 48 | ISSUED FOR OTHER | | | |
| 49 | ISSUED FOR OTHER | | | |
| 50 | ISSUED FOR OTHER | | | |
| 51 | ISSUED FOR OTHER | | | |
| 52 | ISSUED FOR OTHER | | | |
| 53 | ISSUED FOR OTHER | | | |
| 54 | ISSUED FOR OTHER | | | |
| 55 | ISSUED FOR OTHER | | | |
| 56 | ISSUED FOR OTHER | | | |
| 57 | ISSUED FOR OTHER | | | |
| 58 | ISSUED FOR OTHER | | | |
| 59 | ISSUED FOR OTHER | | | |
| 60 | ISSUED FOR OTHER | | | |
| 61 | ISSUED FOR OTHER | | | |
| 62 | ISSUED FOR OTHER | | | |
| 63 | ISSUED FOR OTHER | | | |
| 64 | ISSUED FOR OTHER | | | |
| 65 | ISSUED FOR OTHER | | | |
| 66 | ISSUED FOR OTHER | | | |
| 67 | ISSUED FOR OTHER | | | |
| 68 | ISSUED FOR OTHER | | | |
| 69 | ISSUED FOR OTHER | | | |
| 70 | ISSUED FOR OTHER | | | |
| 71 | ISSUED FOR OTHER | | | |
| 72 | ISSUED FOR OTHER | | | |
| 73 | ISSUED FOR OTHER | | | |
| 74 | ISSUED FOR OTHER | | | |
| 75 | ISSUED FOR OTHER | | | |
| 76 | ISSUED FOR OTHER | | | |
| 77 | ISSUED FOR OTHER | | | |
| 78 | ISSUED FOR OTHER | | | |
| 79 | ISSUED FOR OTHER | | | |
| 80 | ISSUED FOR OTHER | | | |
| 81 | ISSUED FOR OTHER | | | |
| 82 | ISSUED FOR OTHER | | | |
| 83 | ISSUED FOR OTHER | | | |
| 84 | ISSUED FOR OTHER | | | |
| 85 | ISSUED FOR OTHER | | | |
| 86 | ISSUED FOR OTHER | | | |
| 87 | ISSUED FOR OTHER | | | |
| 88 | ISSUED FOR OTHER | | | |
| 89 | ISSUED FOR OTHER | | | |
| 90 | ISSUED FOR OTHER | | | |
| 91 | ISSUED FOR OTHER | | | |
| 92 | ISSUED FOR OTHER | | | |
| 93 | ISSUED FOR OTHER | | | |
| 94 | ISSUED FOR OTHER | | | |
| 95 | ISSUED FOR OTHER | | | |
| 96 | ISSUED FOR OTHER | | | |
| 97 | ISSUED FOR OTHER | | | |
| 98 | ISSUED FOR OTHER | | | |
| 99 | ISSUED FOR OTHER | | | |
| 100 | ISSUED FOR OTHER | | | |

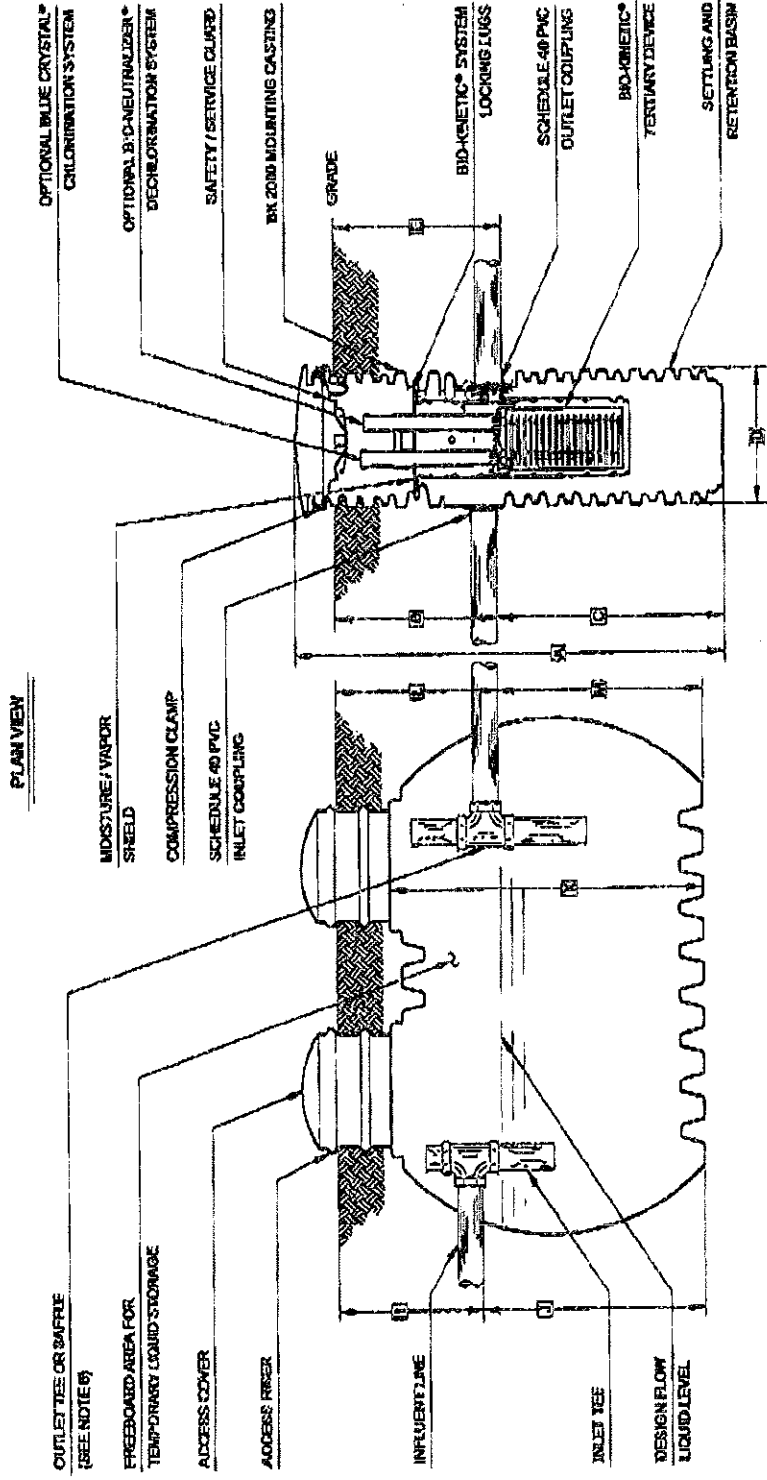
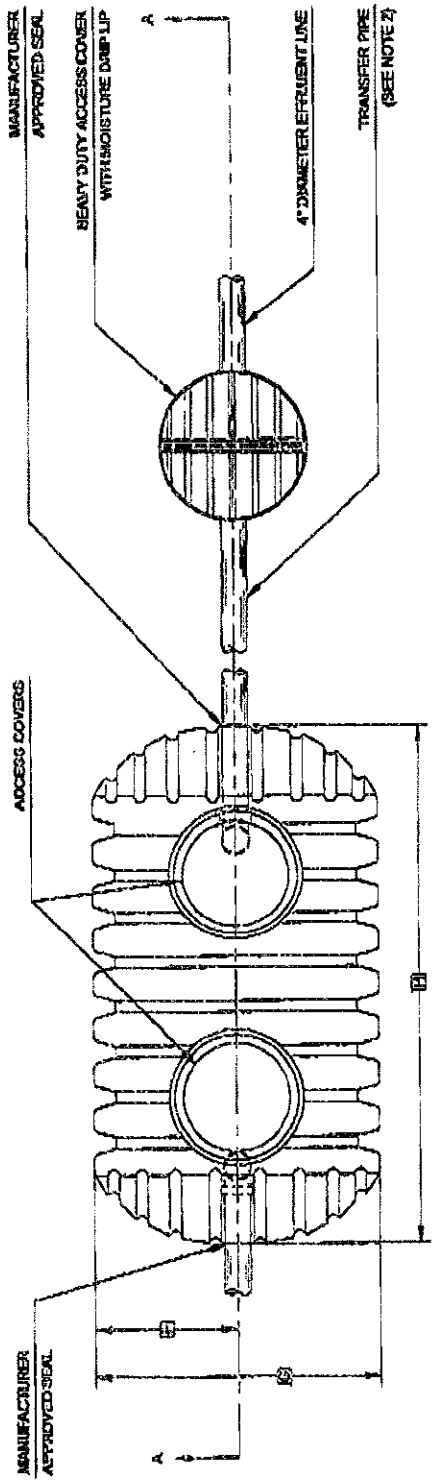

NOTE: SEPTIC TANK MAY BE NON-COMPARTMENTED (AS SHOWN) OR WITH 2 OR MORE COMPARTMENTS.

NOTE: SOME CRITICAL DIMENSIONS ARE INTENTIONALLY LEFT BLANK TO BE FILLED IN PER INDIVIDUAL JOB SITE SPECIFICATIONS.

SECTION A-A

PLASTIC SEPTIC TANK

NOTE: SEPTIC TANK MAY BE NON-COMPARTMENTED (AS SHOWN) OR WITH 2 OR MORE COMPARTMENTS.

September 24, 1999

Norweco
Attn.: Michael S. Price, R.S.
220 Republic Street
Norwalk, OH 44857-1196

Subject: Product Registration, Norweco Bio-Kinetic Wastewater Management System

Dear Mr. Price:

Thank you for your letter dated August 16, 1999 regarding your company's product. Under provisions of Section 1902 of the Maine State Plumbing Code, Subsurface Wastewater Disposal Rules any manufacturer or distributor submitting a new product for code registration needs to demonstrate that:

1. The product is designed to protect public health, prevent the creation of any nuisance, and prevent environmental pollution to the same extent as comparable products presently authorized by Department for use in this code, and
2. The product is based on sound engineering principles and can be expected to provide the same level of protection to public health and the environment as offered by the authorized products presently authorized by the Department for use in this code.

Such demonstration may be achieved by submitting a letter to the Division of Health Engineering from: a) a certifying organization, such as from National Sanitation Foundation (NSF), Building Officials and Code Administrators (BOCA), or other suitable organization stating their approval of the product, or b) the American Society for Testing and Materials (ASTM) indicating the requested product (used as indicated in the request) meets the ASTM standard as specifically listed in the appropriate section of any nationally recognized plumbing code, such as BOCA, IAPMO (same as International Plumbing Code), or equal.

According to the information you provided, Norweco Bio-Kinetic Wastewater Management System has received Standard 40 approval NSF, as part of the Norweco Singulair System. On that basis, the Division has determined that Norweco Bio-Kinetic Wastewater Management System is acceptable for use in the State of Maine, provided that it is installed, operated, and maintained in conformance with the manufacturer's directions.

Page 2;
Norweco Bio-Kinetic Wastewater Management System

Because installation and owner maintenance has a significant effect on the working order of onsite sewage disposal systems, including their components, the Division makes no representation or guarantee as to the efficiency and/or operation of Norweco Bio-Kinetic Wastewater Management System. Further, registration of this product for use in the State of Maine does not represent Division preference or recommendation for this product over similar products.

If you have any questions please feel free to contact me at (207) 287-5695.

Sincerely,

James A. Jacobsen, Manager
Wastewater and Plumbing Control Program
Division of Health Engineering
e-mail: james.jacobsen@state.me.us

xc: Product File



STATE OF MAINE
DEPARTMENT OF HUMAN SERVICES
DIVISION OF HEALTH ENGINEERING
10 STATE HOUSE STATION
AUGUSTA, MAINE
04333-0010

ANGUS S. KING, JR.
GOVERNOR

KEVIN W. CONCANNON
COMMISSIONER

September 24, 1999

Norweco
Attn.: Michael S. Price, R.S.
220 Republic Street
Norwalk, OH 44857-1196

Subject: Product Registration, Norweco Bio-Kinetic Wastewater Management System

Dear Mr. Price:

Thank you for your letter dated August 16, 1999 regarding your company's product. Under provisions of Section 1902 of the Maine State Plumbing Code, Subsurface Wastewater Disposal Rules any manufacturer or distributor submitting a new product for code registration needs to demonstrate that:

1. The product is designed to protect public health, prevent the creation of any nuisance, and prevent environmental pollution to the same extent as comparable products presently authorized by Department for use in this code, and
2. The product is based on sound engineering principles and can be expected to provide the same level of protection to public health and the environment as offered by the authorized products presently authorized by the Department for use in this code.

Such demonstration may be achieved by submitting a letter to the Division of Health Engineering from: a) a certifying organization, such as from National Sanitation Foundation (NSF), Building Officials and Code Administrators (BOCA), or other suitable organization stating their approval of the product, or b) the American Society for Testing and Materials (ASTM) indicating the requested product (used as indicated in the request) meets the ASTM standard as specifically listed in the appropriate section of any nationally recognized plumbing code, such as BOCA, IAPMO (same as International Plumbing Code), or equal.

According to the information you provided, Norweco Bio-Kinetic Wastewater Management System has received Standard 40 approval NSF, as part of the Norweco Singlair System. On that basis, the Division has determined that Norweco Bio-Kinetic Wastewater Management System is acceptable for use in the State of Maine, provided that it is installed, operated, and maintained in conformance with the manufacturer's directions.



PRINTED ON RECYCLED PAPER

Page 2;
Norweco Bio-Kinetic Wastewater Management System

Because installation and owner maintenance has a significant effect on the working order of onsite sewage disposal systems, including their components, the Division makes no representation or guarantee as to the efficiency and/or operation of Norweco Bio-Kinetic Wastewater Management System. Further, registration of this product for use in the State of Maine does not represent Division preference or recommendation for this product over similar products.

If you have any questions please feel free to contact me at (207) 287-5695.

Sincerely,

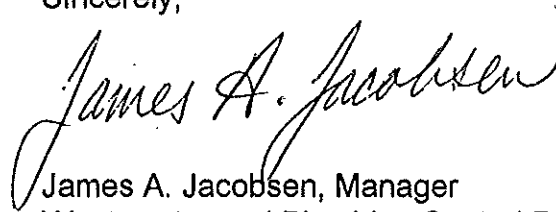
A handwritten signature in cursive script that reads "James A. Jacobsen". The signature is written in black ink and is positioned above the printed name and title.

James A. Jacobsen, Manager
Wastewater and Plumbing Control Program
Division of Health Engineering
e-mail: james.jacobsen@state.me.us

xc: Product File

NORWECO[®]

NORWALK WASTEWATER

EQUIPMENT COMPANY

220 Republic Street
Norwalk, OH 44857-1196 U.S.A.
(419) 668-4471 Fax (419) 663-5440

September 16, 1999

Mr. Kenneth L. Meyer
Community Health Programs
Division of Health Engineering
State of Maine
Department of Human Services
Augusta, Maine 04333



Re: Request for Approval—Bio-Kinetic[®] Wastewater Management System

Dear Mr. Meyer:

Several weeks ago, we requested that your office approve our Bio-Kinetic[®] Wastewater Management System for use within your state. To date, we have not received a response to our written request.

Should you require additional information or have questions about our Bio-Kinetic[®] System, please give us a call. We are anxious to receive your approval and look forward to hearing from you soon.

Sincerely,

NORWECO, INC.

A handwritten signature in cursive script, appearing to read 'Michael S. Price'.

Michael S. Price, R.S.
Vice President, Sales

MSP:rlc



NORWALK WASTEWATER
EQUIPMENT COMPANY
220 Republic Street
Norwalk, OH 44857-1196 U.S.A.
(419) 668-4471 Fax (419) 663-5440

August 16, 1999

Mr. Kenneth L. Meyer
Community Health Programs
Division of Health Engineering
State of Maine
Department of Human Services
Augusta, Maine 04333



Re: Request for Approval—Bio-Kinetic® Onsite Wastewater Management System

Dear Mr. Meyer:

With this letter, we are requesting approval to use the Norweco Bio-Kinetic® Wastewater Management System in conjunction with onsite treatment and disposal systems in the State of Maine. Norweco first introduced the Bio-Kinetic® tertiary device as a component part of the Singulair® Aerobic Wastewater Treatment Plant. The Singulair® Treatment Plant, including the Bio-Kinetic® tertiary device, has been evaluated by NSF International on four separate occasions and was first certified to meet the Class I effluent quality limits of NSF Standard 40 in February of 1990.

As a result of the successful operation of the Bio-Kinetic® tertiary device as an integral component of the Singulair® Wastewater Treatment Plant, we have decided to make the Bio-Kinetic® tertiary device available for other onsite treatment and disposal applications. The enclosed literature describes the Bio-Kinetic® Wastewater Management System, which includes a Bio-Kinetic® tertiary device installed within its own mounting basin.

We are hereby requesting approval to use the Bio-Kinetic® Wastewater Management System in Maine for the following applications:

- For use in onsite wastewater treatment and disposal systems that have already been installed in Maine as a pretreatment tank effluent filtration and flow equalization device.
- For use in newly constructed on-site wastewater treatment and disposal systems in Maine as a pretreatment tank (aerobic or septic) effluent filtration and flow equalization device.

Mr. Kenneth L. Meyer
August 16, 1999
Page 2

Product specifications, an engineering drawing and a general description of product features are enclosed. Should you have any questions concerning this request for approval, do not hesitate to give us a call. Thank you for your consideration and prompt attention to this matter.

Sincerely,

NORWECO, INC.

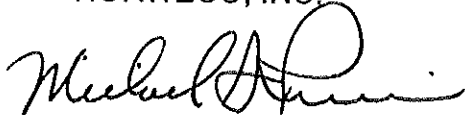

Michael S. Price, R.S.
Vice President, Sales

Enclosures: Bio-Kinetic® Wastewater Management System Specifications
Drawing # PC-5-9530
Solve Onsite Problems

NORWECO

NORWALK WASTEWATER EQUIPMENT COMPANY

220 REPUBLIC STREET, NORWALK, OHIO 44857-1196

BIO-KINETIC®

WASTEWATER MANAGEMENT SYSTEM

MODEL BK 2000

GENERAL SPECIFICATIONS

The contractor shall furnish and install one complete Bio-Kinetic wastewater management system with Bio-Kinetic tertiary device, including all applicable equipment, as described in the following specifications. All domestic wastewater shall pass through the Bio-Kinetic wastewater management system for advanced treatment prior to being returned to the environment. Settling and storage of suspended solids, flow equalization, filtration and chemical addition shall be accomplished for the wastewater treatment facility by the Bio-Kinetic wastewater management system. The advanced treatment system shall be a Bio-Kinetic Model BK 2000 wastewater management system, as manufactured by Norweco, Inc., Norwalk, Ohio, USA. The wastewater management system shall be serviceable from grade and shall include a solids settling and retention basin, Bio-Kinetic tertiary device, inlet and outlet couplings, safety/service guard, lockable access cover, compression clamp, system mounting casting and extension risers as required.

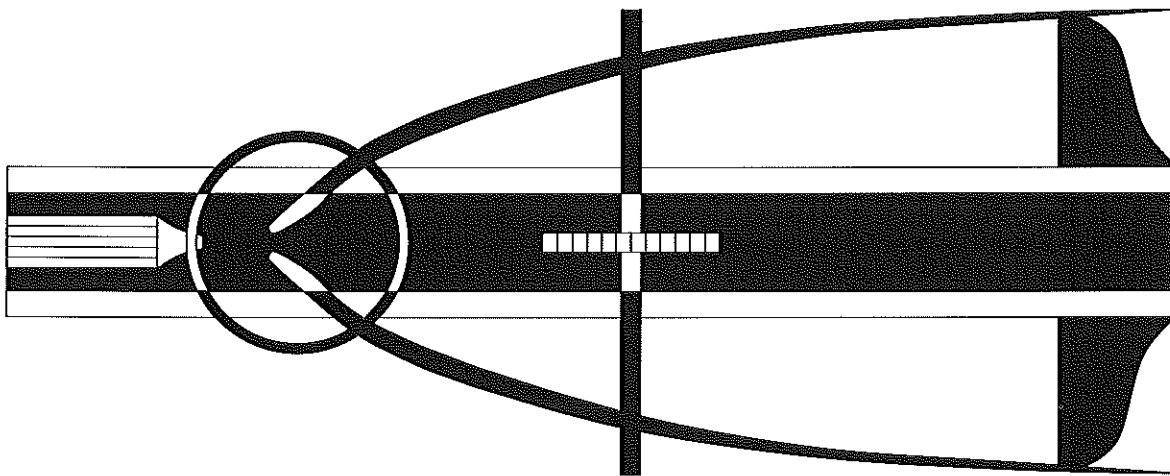

OPERATING CONDITIONS

The Bio-Kinetic wastewater management system shall be an integral part of the overall wastewater treatment and disposal facility. The system shall be rated to accommodate domestic wastewater flows up to 2,000 gallons per day when used downstream of a properly sized treatment facility. Total holding capacity of the wastewater treatment facility shall provide a minimum of 24 hour retention of the average design daily flow. Design of the wastewater treatment facility, including primary/secondary treatment and wastewater management system, shall insure reliable, long term performance without upset even when the significant runoff period is six hours. Hydraulic design considerations of the treatment facility and wastewater management system shall be such that intermittent peak flow factors as high as four shall not upset hydraulic reliability within the facility. Use of the Bio-Kinetic wastewater management system, when installed by an authorized agent, shall be approved by the local governing regulatory agency.

SPECIFICATIONS

BIO-KINETIC®

SETTLING AND RETENTION BASIN

The settling and retention basin shall be designed to remove biosolids from domestic wastewater. Total holding capacity of the retention basin below the outlet invert shall be 52 gallons. For special applications, additional ring sections are available to increase the liquid and solids retention capacity. The retention basin shall be manufactured to be watertight at burial depths of up to 12 feet. The inlet and outlet couplings of the basin shall contain 4" diameter Schedule 40 PVC pipe couplings to permit a solvent weld connection of inlet and discharge piping. Fall through the retention basin and internal components from inlet invert to outlet invert shall be a total of one inch. A system mounting casting to allow access to the retention basin, Bio-Kinetic tertiary device and all internal components shall be provided. The mounting casting shall be equipped with a molded, one-piece, heavy duty, ribbed, removable access cover with moisture drip lip. The access cover shall be securely installed such that the moisture drip lip is 3" above finished grade. The cover shall be secured to the retention basin by an injection molded compression clamp with lock tab to prevent unauthorized access. The retention basin shall be equipped with a safety/service guard. The safety/service guard shall be installed below the retention basin cover and securely connected to the mounting casting by a retainer cable. The internal safety/service guard shall be designed to prevent accidental entry and be supported by the uppermost internal rib of the mounting casting. To prevent loss or theft, the safety/service guard shall be permanently connected to the retention basin by stainless steel cable. The retention basin, optional ring sections, safety/service guard, access cover and system mounting casting shall be constructed of corrosion resistant, UV stabilized polyethylene. All joints within the retention basin shall be sealed with a closed cell foam gasket and injection molded compression clamp secured with bolted lock tab. The retention basin shall be an integrally molded, heavy duty, one-piece unit, with only one clamp required to attach the access cover. For deeper installations, additional clamps shall be used to connect ring sections and extension risers to the retention basin. Where special shipping considerations apply, the retention basin may be shipped in individual sections for field assembly with compression clamp.

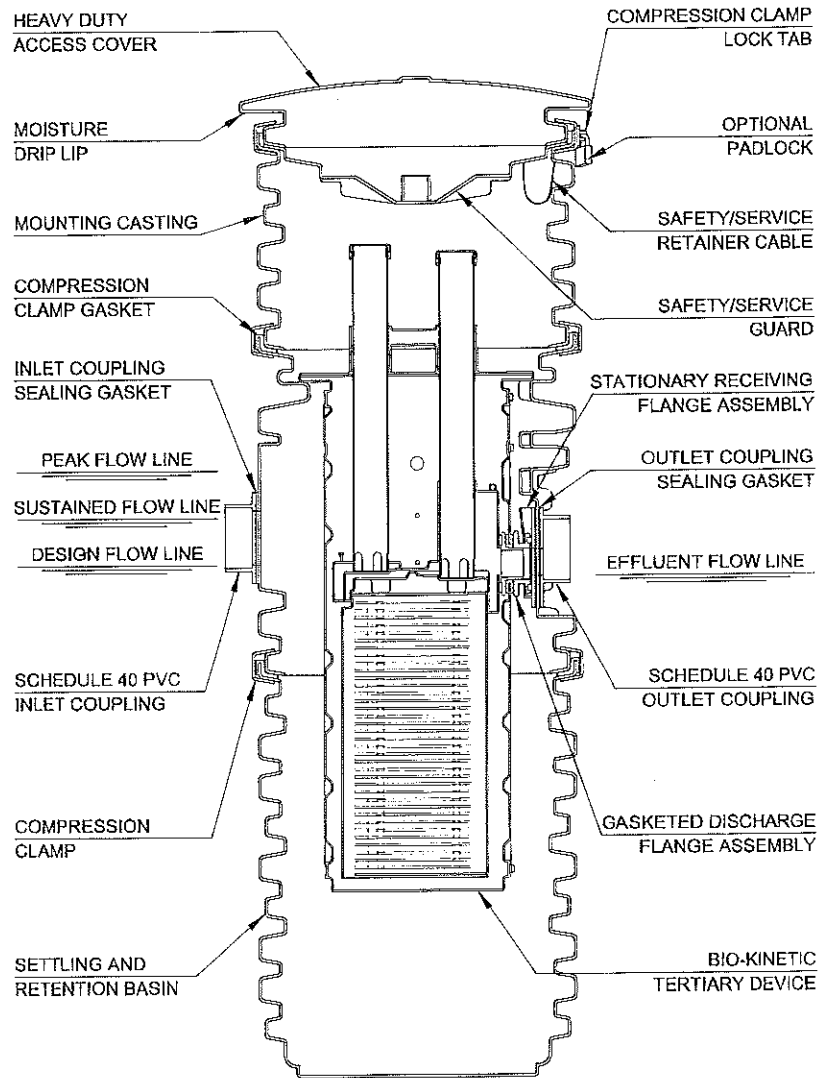

EXTENSION RISERS

BK 2000 SYSTEM

For installations where the inlet invert of the retention basin is more than 28" below finished grade, optional extension risers shall be installed. Extension risers shall be constructed of the same material as the retention basin, optional ring sections and mounting casting. To permit maximum installation flexibility and to accommodate various treatment system elevations, individual extension risers shall be available in 6" increments from 6" up to 72" in height. When an extension riser is used, the internal safety/service guard shall be mounted in the uppermost rib of the riser, directly below the access cover. Extension risers shall be connected to the mounting casting and sealed with a closed cell foam gasket and injection molded compression clamp.

MODEL BK 2000

BIO-KINETIC® TERTIARY DEVICE

A Bio-Kinetic tertiary device shall be connected to the outlet coupling within each retention basin. Suspended and settleable solids shall be removed from the wastewater flow and retained within the basin and/or the three separate filtration zones and eight independent settling zones of the Bio-Kinetic tertiary device. Each Bio-Kinetic tertiary device shall provide non-mechanical flow equalization through all gravity flow treatment processes of the upstream and downstream wastewater facility, including (as applicable) pretreatment, anaerobic treatment, aerobic treatment, clarification, filtration, chlorination, dechlorination and surface or subsurface effluent disposal systems. The Bio-Kinetic device shall be supplied with locking lugs and removable cover and shall consist of a design flow and peak flow micronically molded filter, baffled perimeter settling zone, non-mechanical flow equalization, flow distribution deck, lifting handles, level indicator, adjustment lugs, chlorination feed tube, unbaffled perimeter settling zone, solids contact zone, vertical inlet zone, compartmented settling zone consisting of thirty-seven baffled chamber plates, effluent stilling well, final discharge zone, adjustable outlet weir, dechlorination feed tube, outlet zone and gasketed discharge flange. All components shall be manufactured from inert synthetic materials or rubber, assembled in circular fashion and connected to a PVC outlet coupling. The outlet coupling shall permit a solvent weld connection to the discharge piping. Each Bio-Kinetic device shall be installed such that the inverts of the design flow equalization ports are located at the normal liquid level of the gravity flow treatment facility. If intermittent flow rates exceed the capacity of the design flow ports, flow shall be held upstream until the intermittent flow dissipates or continues to increase. If the intermittent flow continues to increase, it will reach the pair of sustained flow equalization ports. With four ports in use, flow through the system increases while the Bio-Kinetic device continues to provide non-mechanical flow equalization to all upstream and downstream processes. Two peak flow equalization ports shall be supplied to equalize intermittent periods of peak hydraulic loading. Blue Crystal tablet chlorination system and Bio-Neutralizer tablet dechlorination system feed tubes shall be positioned such that the flow-activated chemical cannot make contact with the liquid upstream of the feed tubes. Treatment systems utilizing only slotted or screen filtration do not provide non-mechanical flow equalization throughout all gravity flow processes or chemical addition and shall not be considered for this application.

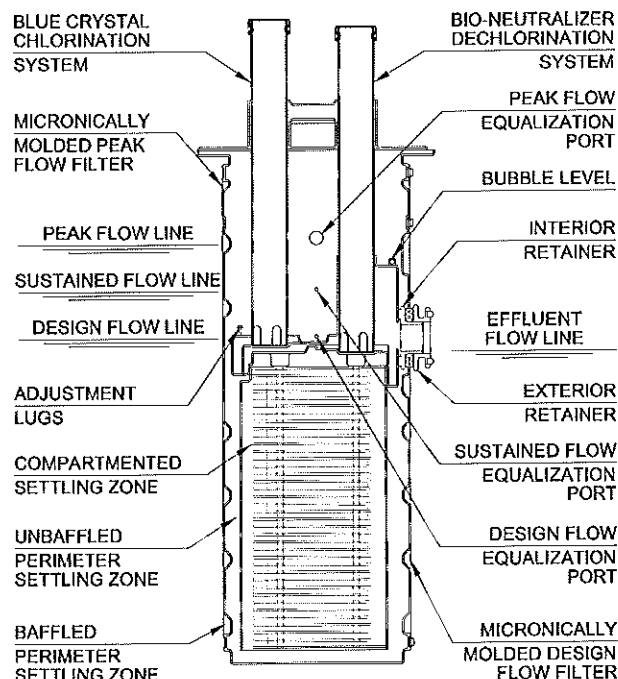

BIO-KINETIC SYSTEM

NON-MECHANICAL FLOW EQUALIZATION

The Bio-Kinetic device shall provide non-mechanical, demand use, flow equalization to the entire gravity flow wastewater treatment facility. Flow equalization shall control normal residential flow rates and reduce typical residential flow surges (e.g. shower @ 10 minutes duration, bathtub discharge @ 5 minutes duration, clothes washer discharge @ 2 minutes duration, and dishwasher discharge @ 2 minutes duration). The flow equalization rate shall be dependent upon the hydraulic loading pattern, the duration of flow surges and the size of the treatment facility tankage. In order to fully utilize the upstream flow equalization capacity, the transfer pipe connecting the upstream facility to the Bio-Kinetic wastewater management system shall be not longer than 10 feet and shall fall no more than 1/4" over the entire length. The transfer pipe may be installed at greater length and/or with more fall, but shall result in decreased flow equalization rates that are dependent upon overall pipe length and total fall. At a 2,000 gallon per day residential loading pattern, minimum performance of the device shall equalize daily flow an average of 50% when used with a treatment facility having at least 40 square feet of upstream liquid surface area. Flow equalization shall increase detention time of the wastewater in all treatment processes and shall prevent hydraulic upset and solids washout. Flow equalization shall result in additional solids being retained in the upstream portion of the treatment facility, insuring fewer and more stabilized solids in the effluent. Remaining solids shall be further reduced by the Bio-Kinetic wastewater management system. Reduced hydraulic and organic loading shall result in increased treatment and disposal system life.

BLUE CRYSTAL® CHLORINATION SYSTEM

The BK 2000 shall be equipped with a supply of Blue Crystal disinfecting tablets installed in the chlorine feed tube of the wastewater management system. Blue Crystal tablets shall be specifically formulated for consistent chlorine dosage to the sustained, variable and intermittent flows that are typical of domestic wastewater treatment systems. The tablets shall be manufactured from pure calcium hypochlorite and shall contain a minimum of 70% available chlorine. The tablets shall incorporate beveled edges to enhance the chemical dissolution pattern. Each tablet within the feed tube shall be 2⁵/₈" diameter, compressed to a 1³/₁₆" thickness, weigh approximately 5 ounces and be white in color with blue crystals for easy identification. The tablets shall dissolve in direct proportion to the flow rate, releasing controlled amounts of chlorine.

BIO-NEUTRALIZER® DECHLORINATION SYSTEM

The BK 2000 shall be equipped with a supply of Bio-Neutralizer dechlorination tablets installed in the dechlorination feed tube of the wastewater management system. The active ingredients of the dechlorination tablets shall be specifically formulated to chemically neutralize both free and combined chlorine. The tablets shall incorporate beveled edges to enhance the chemical dissolution pattern. Each tablet within the feed tube shall be 2⁵/₈" diameter, compressed to a 1³/₁₆" thickness, weigh approximately 5 ounces and be green in color for easy identification. The tablets shall dissolve in direct proportion to the flow rate, releasing controlled amounts of chemical for the instantaneous removal of residual chlorine.

TEN YEAR LIMITED WARRANTY

The manufacturer shall provide a limited warranty against defects in material and workmanship under normal use and service for a period of ten years. The limited warranty shall cover all components of the Bio-Kinetic wastewater management system purchased from the manufacturer, including retention basin, ring sections, safety/service guard, access cover, system mounting casting, extension risers and Bio-Kinetic tertiary device. A detailed copy of the warranty shall be provided to the regulatory agency, contractor and customer as required.

EQUIPMENT MANUFACTURER

The equipment specified herein shall be the product of a manufacturer having a minimum of seven years experience in the construction of prefabricated wastewater treatment equipment and systems. Bids shall be prepared on the basis of the equipment and material specified herein for purposes of determining the low bid. This is not done, however, to eliminate other products of equal quality and efficiency. If equipment is to be substituted, approval of such substitution must be made prior to the execution of any order. It is assumed that substitution will result in a reduction of cost to the contractor and that if accepted, these savings will be passed along by a reduction in the base bid.

PROGRESS THROUGH SERVICE SINCE 1906



220 REPUBLIC STREET
NORWALK, OHIO, USA 44857-1196
TELEPHONE (419) 668-4471
FAX (419) 663-5440
EMAIL email@norweco.com

DISTRIBUTED LOCALLY BY:

Norweco®, Singulair®, Modulair®, Travalair®, Microsonic®, Lift Rall®, Bio-Kinetic®, Bio-Sanitizer®, Bio-Neutralizer®, Bio-Static®, Bio-Dynamic®, Bio-Gem®, Blue Crystal®, Grease Buster® and "BUSTER" logo® are registered trademarks of Norwalk Wastewater Equipment Company, Inc.

©MCMXCIX NORWECO, INC.

SOLVE ONSITE PROBLEMS WITH THE BK 2000

BIO-KINETIC®

WASTEWATER MANAGEMENT SYSTEM

Finally, a system that can solve the problems associated with existing domestic wastewater treatment plant failures and prevent problems from occurring in new installations. The BK 2000 has been developed to improve the performance and operating life of both new and existing septic tanks, aerobic systems, leach fields, sand filters, mounds, constructed wetlands, grease traps and oil interceptors. Utilizing advanced treatment methods, the BK 2000 protects domestic treatment plants from hydraulic surges, biosolids washout and organic overload without the use of electricity and with no moving parts. Engineers, contractors and regulators are actively searching for a means to prevent and remedy system failures associated with marginal soils, high groundwater, hydraulic or organic overload and systems past their useful lives. You can help them solve their problems. Compare these features and benefits as you evaluate the BK 2000 Wastewater Management System.

Provides Advanced Wastewater Treatment to Primary or Secondary Facilities, Resulting in Improved Effluent Quality, Longer System Life, Ease of Service and Environmental Protection...

- ❑ The BK 2000 removes BOD, suspended and settleable solids from wastewater and provides chemical treatment and non-mechanical flow equalization for any treatment facility. This is accomplished in a compact, easily installed and serviceable system.
- ❑ Simple sand, gravel, slotted or screened filters do not provide the advanced treatment or level of protection delivered by the BK 2000. These filters frequently plug and result in flow backing up into the home.
- ❑ Chemical treatment can be easily added to safely deliver a potent disinfectant or provide dechlorination prior to effluent discharge. The flow pattern through the eight settling zones of the Bio-Kinetic tertiary treatment device creates near plug flow conditions, thereby making sure chemicals are adequately mixed with the liquids to be treated.

Protects New as well as Existing Wastewater Treatment and Disposal Systems from Expensive Renovation or Complete Replacement...

- ❑ Treatment and disposal systems regularly fail when hydraulic surges wash out biosolids and plug the soil or filter media. The BK 2000 controls the amount of biosolids discharged from treatment tanks. Soils and filter media are protected and the proper operation of the entire treatment system is maintained.
- ❑ Expensive onsite systems (filter beds, sand filters, mounds, wetlands, evapotranspiration systems, etc.) are becoming more and more popular with designers and regulators. Unfortunately, the performance of these systems is not failsafe and replacement costs can be tens of thousands of dollars. The installation of a BK 2000 enhances system performance, protecting the owner's investment and the environment.
- ❑ The BK 2000 is easily installed as part of any new or existing treatment system, including septic tanks, aerobic systems, grease traps and oil interceptors.

Non-Mechanical, Demand Use Flow Equalization Enhances Treatment and Protects the Effluent Disposal System and Receiving Environment...

- ❑ Using patented, field proven technology, the BK 2000 equalizes flow through all treatment and effluent disposal stages. Daily residential flow can be equalized an average of 50%. No other system delivers such a high percentage of flow equalization without pumps, float switches, control valves and complex electrical controls.
- ❑ When flow into the BK 2000 increases, the flow equalization automatically increases, insuring that the design detention time for all upstream and downstream processes is maintained. With a BK 2000 in place, any onsite system can function effectively even during periods of peak hydraulic or organic loading.
- ❑ Many onsite systems fail because they are not equipped with a means to equalize flow. Everyday surges in flow can cause tanks to discharge raw sewage and biosolids that eventually make soils and other treatment media unusable. The BK 2000 eliminates solids washout by regulating the wastewater flow through the system, protecting receiving environments and ensuring long-term performance.

Easily Installed in Existing or New Domestic Treatment Plants to Solve and Prevent Problems...

- ❑ BK 2000 basins and accessories are manufactured from easy to handle, corrosion resistant, U.V. stabilized polyethylene. Inlets and outlets are built-in and will accept 4" diameter schedule 40 PVC pipe.
- ❑ The BK 2000 basin is a watertight, one-piece unit. If special shipping considerations apply or a riser is required, all joints in the basin are sealed watertight with a gasket and clamp. The heavy duty, one-piece access cover blends nicely into any landscape.
- ❑ When upgrading onsite systems, the existing tankage and effluent sewer line do not have to be abandoned. An excavation large enough to accept the BK 2000 basin for connection to the existing inlet and discharge piping is all that is required.

SOLVE PROBLEMS WITH BK 2000 (Cont.)

Improves the Operation of any Domestic Treatment System by Protecting the Treatment Processes and Eliminating Hydraulic Surges...

- ❑ Flow into a domestic wastewater treatment system is really a series of short hydraulic surges. The frequency and duration of these surges are unpredictable and difficult to accommodate with conventional designs. The BK 2000 upgrades a conventional system to a complete, advanced treatment facility.
- ❑ Flow equalization, solids retention and filtration provided by the BK 2000 will help an existing or proposed wastewater system perform better. The BK 2000 removes additional suspended solids and BOD from treatment plant effluent and prevents hydraulic surges from washing excessive amounts of biosolids into the receiving environment.
- ❑ Flow equalization maintains the design detention time in wastewater treatment processes, resulting in fewer biosolids being discharged from the treatment system and a higher quality effluent. Improved effluent quality increases the operating life of sand filters, mounds, wetlands, leaching beds and other soil absorption and treatment systems. Improved effluent quality will increase the operating life of the treatment system and may allow the engineer or regulator to decrease the overall size of the treatment and disposal system.

Any Residential, Commercial or Industrial Installation can be Equipped with the BK 2000...

- ❑ When used in residential applications, each BK 2000 is capable of handling domestic wastewater flows up to 2,000 gallons per day. In addition, multiple systems can be connected in series or parallel for use in a wide range of centralized, commercial and industrial wastewater applications.
- ❑ The BK 2000 can be used in larger capacity or high strength waste applications. The benefits of solids removal, non-mechanical flow equalization and chemical addition are particularly useful in these troublesome applications.
- ❑ Blue Crystal Chlorination and Bio-Neutralizer Dechlorination Systems are available within the BK 2000. These optional features safely disinfect and dechlorinate wastewater effluent while eliminating the need for separate tablet feeders, contact chambers, manholes or feeder enclosures.
- ❑ The modular design of the BK 2000 allows multiple systems to be installed in new or existing facilities for virtually any wastewater treatment requirement.

Safe and Economical to Install while Eliminating the Need to Enter a Confined Space...

- ❑ The standard BK 2000 can be buried up to 12 feet deep. Extension risers from 6" to 72" in height are available for installation where the inlet piping is more than 28" below finished grade.
- ❑ Installation does not require modifications of existing tankage. No concrete to break, no baffles to remove and no outlets to modify. All installation work can be completed within a few hours without having to rearrange the existing landscape or enter a tank.
- ❑ Access into the basin is limited by the use of a reinforced, lockable cover. When the access cover is removed, a safety/service guard, permanently connected to the basin by a stainless steel retainer cable, prevents accidental entry.

Service Contracts can be Customized to Meet the Needs of Owners, Distributors, Dealers, Contractors and Regulators...

- ❑ The BK 2000 is serviceable from grade without having to use a rake, shovel or backhoe. There are no moving parts or electrical components. A routine service call lasts approximately 15 minutes or less if the Bio-Kinetic tertiary treatment device is exchanged.
- ❑ Pre-scheduled service calls eliminate expensive disposal system failures and keep the wastewater treatment system operating as designed.
- ❑ Service frequency of the BK 2000 will vary according to the wastewater characteristics and the daily flow rate. The normal service cycle is six months to one year. Service to the BK 2000 can be performed by the customer or incorporated into an existing service program. Charges can be on a per call basis or part of an extended service agreement.

Ten Year Limited Warranty on All Components of the BK 2000 Protects Property Value...

- ❑ The BK 2000 is warranted against defects in material and workmanship during normal use and service for ten years. The ten year limited warranty provides comprehensive single source protection.
- ❑ The BK 2000 is the only wastewater management system available with professional service and a ten year limited warranty. Owners, distributors, dealers, contractors and regulators can rest assured that the BK 2000 will cost effectively protect their investment and their environment.

PROGRESS THROUGH

NORWECO
NORWALK WASTEWATER EQUIPMENT COMPANY

SERVICE SINCE 1906

